

Metor 150

Installation and Operating Manual

9100 085-4VE Edition : 8.20

Rapiscan[®]
s y s t e m s

An OSI Systems Company



CONTACT INFORMATION

Please use this address when you order parts or you need support in assembling, operating or programming your Metor metal detector.

FINLAND

Nihtisillankuja 5, P.O. Box 174
FIN-02631 Espoo, FINLAND
Tel: +358 9 3294 1500
Fax: +358 9 3294 1302

USA - NEW JERSEY

8 Commerce Way, Suite 115
Robbinsville, NJ 08691
UNITED STATES of AMERICA
Tel: +1 609 406 9000
Fax: +1 609 530 0842
Toll Free: 1 800 963 8676

ASIA PACIFIC

240 Macpherson Road
#06-04 Pines Industrial Building
SINGAPORE 348574
Tel: +65 6743 9892
Fax: +65 6743 9885 / 6743 9915

service@rapiscansystems.com
sales@rapiscansystems.com

WARRANTY

Rapiscan Systems Oy warrants the Meteor 150 against defects in materials and workmanship in normal use. Within this warranty, Rapiscan Systems Oy will at its option replace or repair any part of the Meteor 150 that has become defective within two years from the date of delivery because of defect in material or workmanship, and that has been returned freight prepaid.

THIS WARRANTY IS THE ONLY WARRANTY GIVEN BY Rapiscan Systems Oy AND IS GIVEN IN LIEU OF ANY OTHER WARRANTY, EXPRESS OR IMPLIED.

Rapiscan Systems Oy DISCLAIMS ANY IMPLIED WARRANTIES OF MERCHANTABILITY OR FITNESS FOR A PARTICULAR PURPOSE.

Rapiscan Systems Oy RESPONSIBILITY TO REPAIR OR REPLACE DEFECTIVE PRODUCTS IS THE SOLE AND EXCLUSIVE REMEDY FOR BREACH OF THIS WARRANTY.

LIABILITY

Rapiscan Systems Oy products are warranted for proper operation when used in accordance with the specifications listed in this document. Product performance is affected, to some extent, by external factors that are beyond control of the manufacturer and therefore Rapiscan Systems Oy is not liable for any indirect, special, incidental or consequential damages to the equipment or to any person(s) or facility(s) due to the evasive action of any individuals or improper implementation of the equipment.

The information contained in this manual is as complete and up to date as possible but Rapiscan Systems Oy reserves the right to perform any design modifications or changes to features or specifications it deems necessary to improve its products, without notice.

**PROPRIETARY
NOTICE**

The information contained in this manual and all designs expressed herein are the property of Rapiscan Systems Oy. Rapiscan Systems Oy reserves all proprietary designs, patents, manufacturing and sales rights except to the extent rights are expressly granted to others.

Reproduction of any part of this document or any other item deemed the property of Rapiscan Systems Oy strictly prohibited without prior written permission of Rapiscan Systems.

SAFETY PRECAUTIONS

The Metor 150 will not erase, alter, or damage magnetic storage media including credit cards, computer floppy disks, tapes, or IC's. **The Metor 150 is designed to protect people** wearing pacemakers, pregnant women, the operator, and general pedestrian traffic **from any possible effects of its electronics or magnetic field operation.**

Before the unit is turned on, the following precaution should be taken to protect the user's safety and provide reliable operation.

- 1) Connect the unit to a **grounded outlet** in compliance with local regulations.
- 2) Connect the unit to a voltage source (mains or DC) only when **the electronics box is closed.**
- 3) If a **backup battery supply** is used, the equipment will continue to operate until the battery connection is disconnected, regardless of the position of the power switch.
- 4) Only a **qualified person** is allowed to open the electronics unit.

Author O. Rantala/ij	Rev. 8.20	Code 9100 085-4VE
Approved	Date 14.3.2006	Document
Product Metor 150	Archives M150	
Title INSTALLATION AND OPERATING MANUAL		

TABLE OF CONTENTS

Page

1 GENERAL INFORMATION

1.1	Introduction	1-1
1.2	Operating Principle	1-2

2 INSTALLATION

2.1	Choice of Installation Site	2-1
	2.1.1 Interferences	2-1
	2.1.2 Check Point Layout	2-2
2.2	Unpacking	2-4
2.3	Mechanical Assembly	2-5
2.4	Electrical Connections	2-9

3 OPERATION

3.1	Switching On/Off	3-1
3.2	Adjustments	3-3
3.3	Program Selection	3-15
	3.3.1 Software version WD01	3-15
	3.3.2 Detection Programming	3-21
3.4	Test and Setting Programs	3-22
	3.4.1 PG55 factory settings	3-22
	3.4.2 PG56 coils condition monitoring "Cm"	3-24
	3.4.3 PG63 noise measurement mode "NS"	3-24
	3.4.4 PG64 programmable reset time "AT"	3-25
	3.4.5 PG66 automatic sensitivity adjustment	3-26

4 OPERATIONS AND OPTIONS

4.1	Multiple Array Operations	4-1
4.2	Alarm Contact	4-2
4.3	Keyboard Inhibition	4-3
4.4	Battery Backup	4-4
4.5	Display Unit	4-5
4.5	Object Speed Responses	4-6
4.6	Alarm Inhibition Operations	4-8

<u>TABLE OF CONTENTS (continued)</u>		Page
5	SPECIAL CONSIDERATIONS	
5.1	Theory of Operation	5-1
5.1.1	Shape vs. Weight	5-1
5.1.2	Metal Types	5-1
5.1.3	Ambient Signal	5-1
5.1.4	Steel-Reinforced Shoes	5-2
6	MAINTENANCE	
6.1	Cleaning	6-1
6.2	Servicing Requirements	6-1
6.3	Fault Tracing and Displays	6-1
6.4	Interference Compensation	6-8
6.5	Spare Parts	6-11
6.6	Optional Accessories	6-12
7	TECHNICAL SPECIFICATIONS	
7.1	Metor 150	7-1
7.2	Electronics Unit	7-3
7.3	Control Unit	7-6
APPENDIX		
1	ALPHABETICAL INDEX	
2	SERVICE REPORTING	

SECTION 1

GENERAL INFORMATION

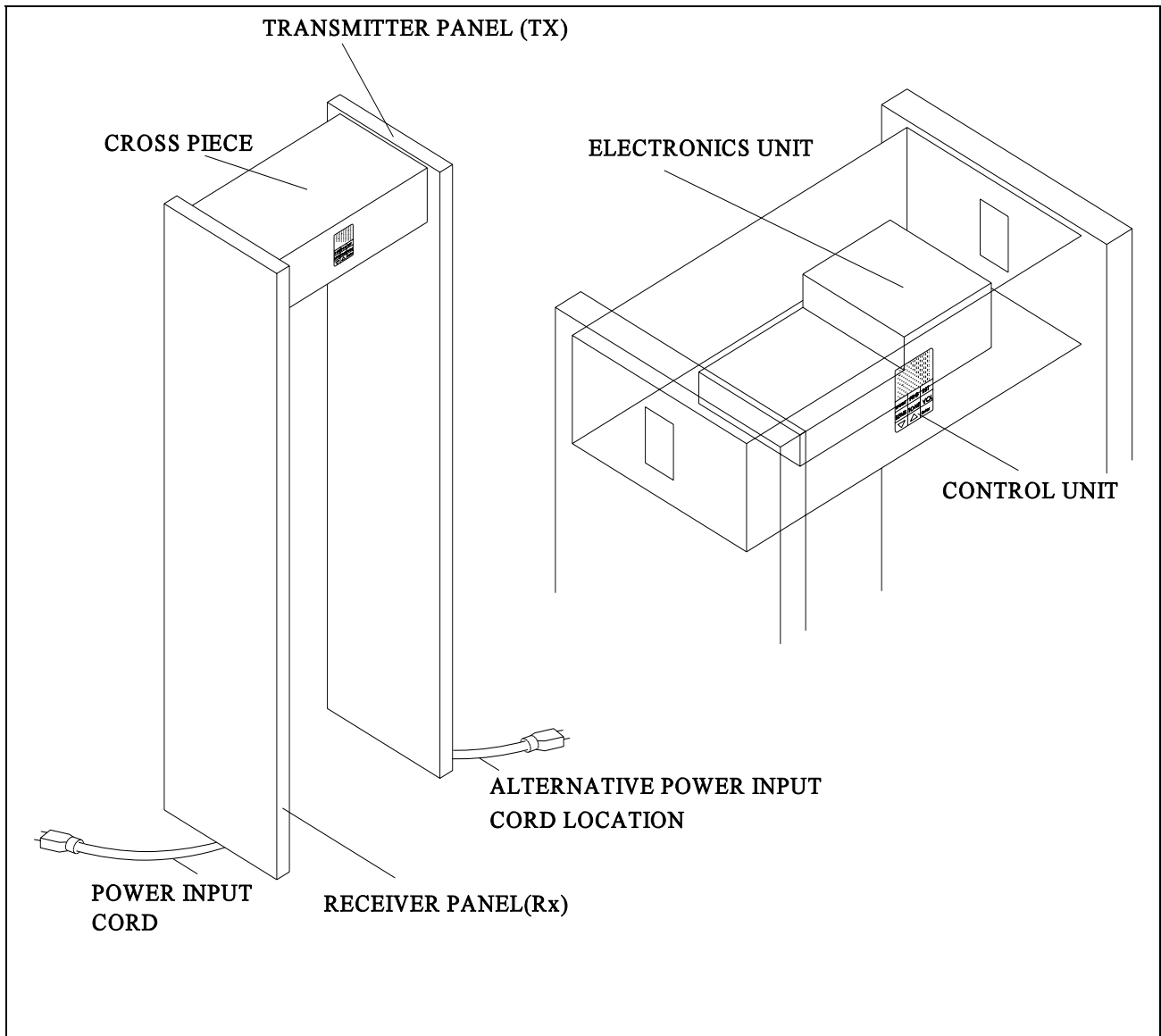

Figure 1-1. The Metor 150

1.1 Introduction

The Metor 150 is a **walk-through metal detector** designed to detect metal objects people are carrying through the coil gate. The system is **used for weapons detection and pilferage prevention**. Typical applications are:

- Airports: passengers screening.
- Banks: holdup prevention.
- Prisons: screening visitors and prisoners.
- Industry: pilferage prevention and access control.
- Courthouses: screening visitors.
- Conferences, public buildings, sporting events: access control.

The Metor 150 is **an integrated, standalone metal detector** which includes the following main parts:

- Electronics unit
- Control unit
- Transmitter panel
- Receiver panel
- Cross piece
- Power cord

The electronics unit, containing two printed circuit boards, is enclosed in a metallic box with connection for cables to other parts of the detector and external purposes.

The cross piece serves as a mechanical support for the coil panels and houses the electronics unit.

The control unit has a keyboard for the control buzzer and lights for alarm monitoring. This unit is internally mounted.

1.2 Operating Principle

The operation is based on **electromagnetic pulsed-field technology**:

- Transmitter pulses cause decaying eddy currents in metal objects inside the sensing area of the coil.
- The signal induced to the receiver by the eddy currents is sampled and processed in the electronics.
- Moving metal is detected when the signal exceeds the alarm threshold.

The Metor 150 is **a dual-channel** metal detector with two crossed, sequentially pulsed, magnetic fields. This ensures the detection of rod shaped metal objects, regardless of orientation.

The use of **advanced micro processor technology** in the Metor 150's digital signal processing and internal controls ensures the metal detector will function reliably.

SECTION 2

INSTALLATION

2.1 Choice of Installation Site To ensure optimum performance, there are a few considerations which must be observed when planning the metal detector installation site. If these factors adhere to the reasonable sensitivity level, the checking point will have **the maximum traffic flow.**

2.1.1 Interferences It is useful to **minimize the possibility for interference** that may affect the operation of the Meteor 150. The following factors are recommendations that should be followed as closely as possible when selecting the installation site.

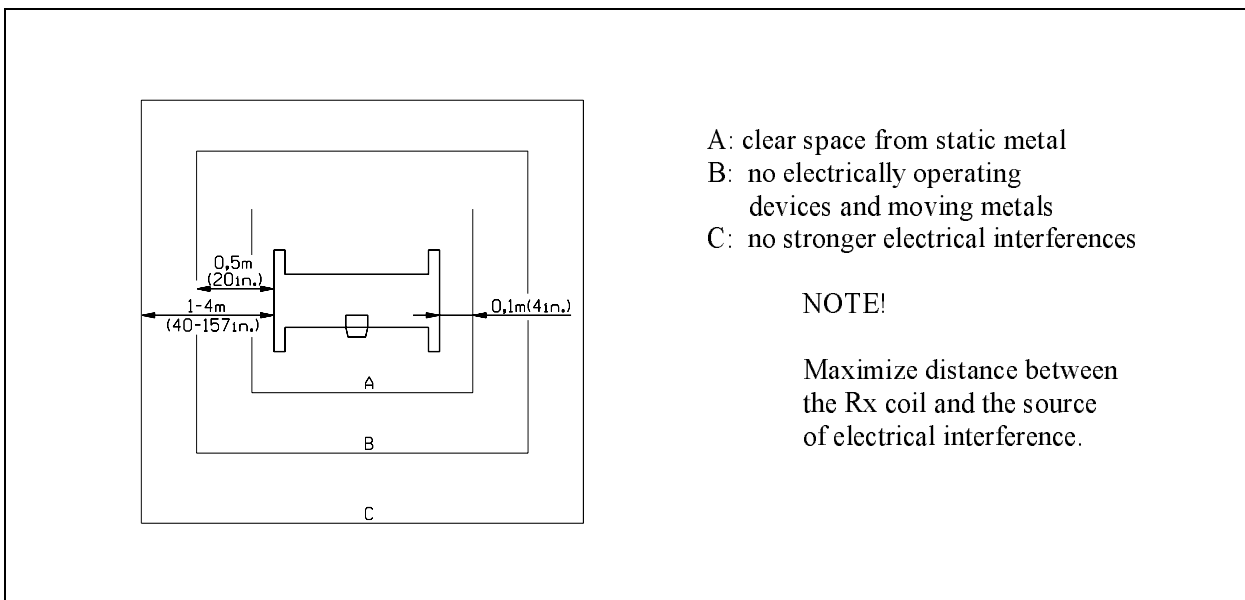

Figure 2-1. **Recommended distances from interference sources**

Conducted electrical interferences

Plug the power cord to a line that is not shared with heavy loads like large electric motors, which can generate large power surges or voltage spikes.

Radiated electrical interferences

To prevent problems, **the distance from interference sources to the receiver coil should be maximized.** Recommendation for minimum distance is from 0.5 m to 4 m (20 in - 157 in). The exact distance can only be determined experimentally case by case. Moving and pivoting the gate will obtain the best operation.

Interferences may be generated by radio and computer equipment, video monitors, powerful electric motors and transformers, AC power cables, thyristor control circuits, flickering fluorescent lighting and arc welding equipment.

Static Metal	Static or stationary, large, metal objects should be at least 0.1 m (4 in) away from the metal detector. The effect on sensitivity is minimal but may make the unit more prone to the effects of vibration.
Floor Vibration	The floor should be level and solidly supported so there is no vibration. If the gate shakes when people walk through, or for some other reason, it could cause the metal detector to false alarm.
Moving Metal	<p>Moving, large, metal objects should be kept at least 0.5 m (20 in) from the gate to avoid false alarms.</p> <p>These objects include metal doors, metal gates, hand trucks, mail carts, and armed guards who pass too close to the outside of the metal detector.</p> <p>The optional shield panel can be used to decrease the effect of moving metal.</p>
2.1.2 Check Point Layout	There are factors effecting the satisfactory operation of a check point equipped with the Metor 150.
Personal Metal Items	Checking of hand luggage should be organized so that it does not cause false alarms.
Searching for Detected Objects	The search for detected metal objects should not disturb the normal checking operation in the metal detector.

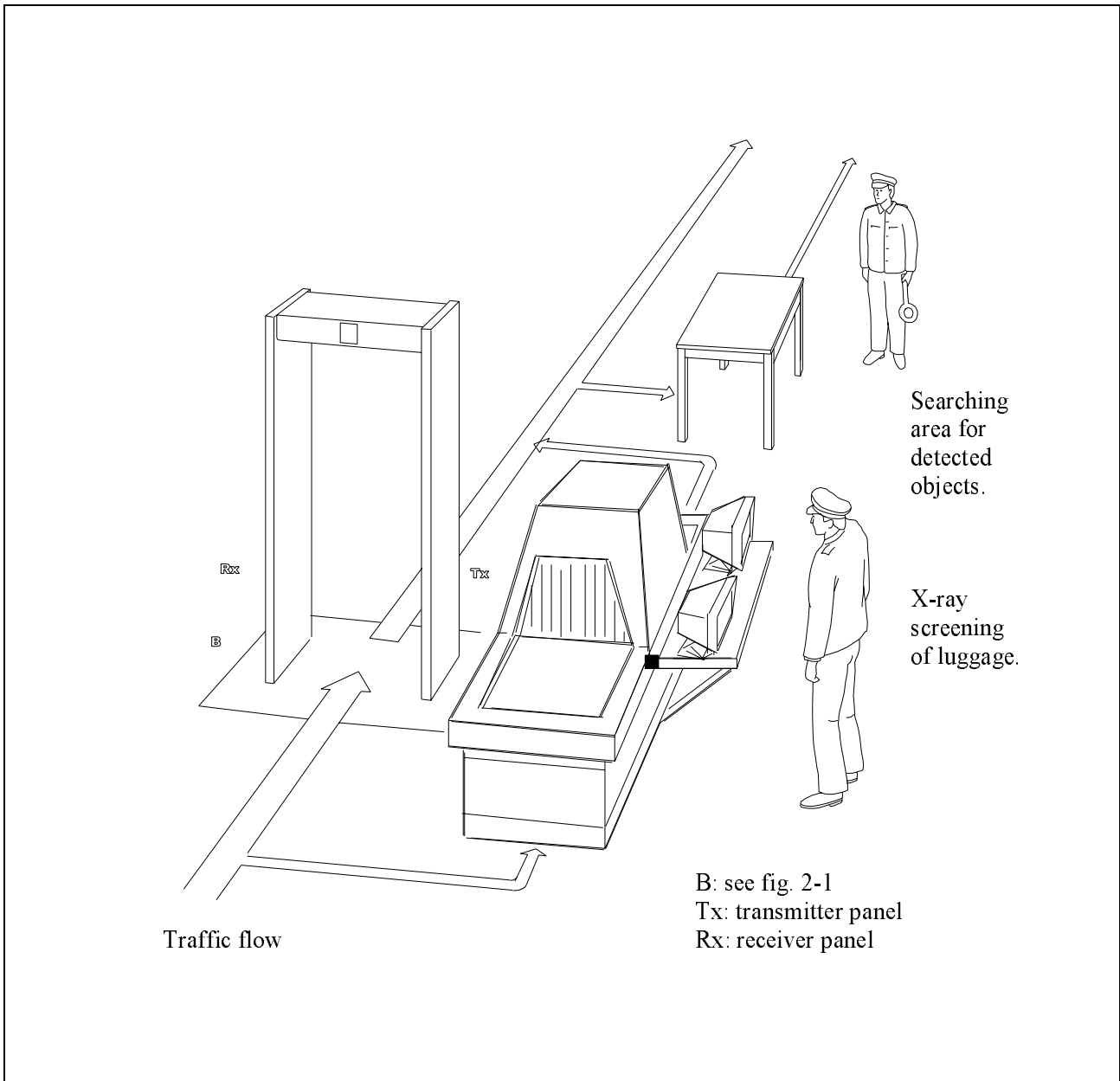

Figure 2-2. Example of security check point layout

**2.2
Unpacking**

The standard Metor 150 package includes **two cardboard boxes** suitable for airfreight and truck transportation.

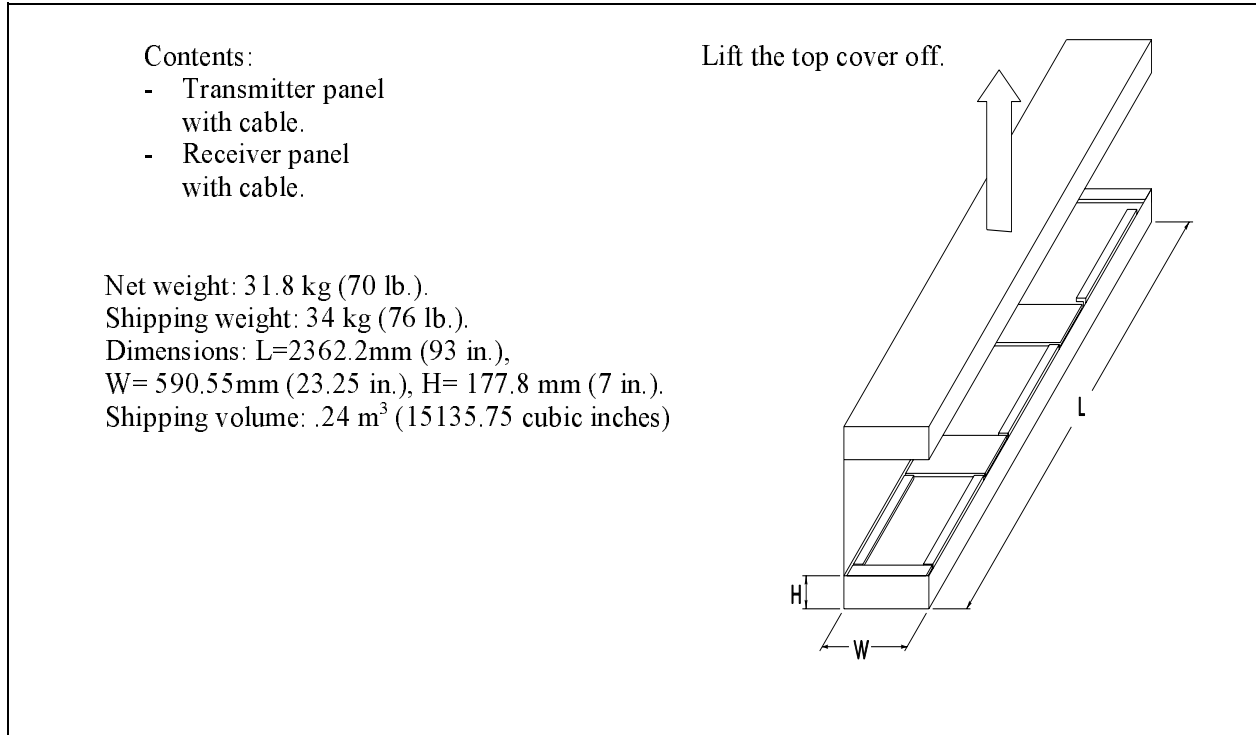

Figure 2-3. Unpacking of the Metor 150 coil panels

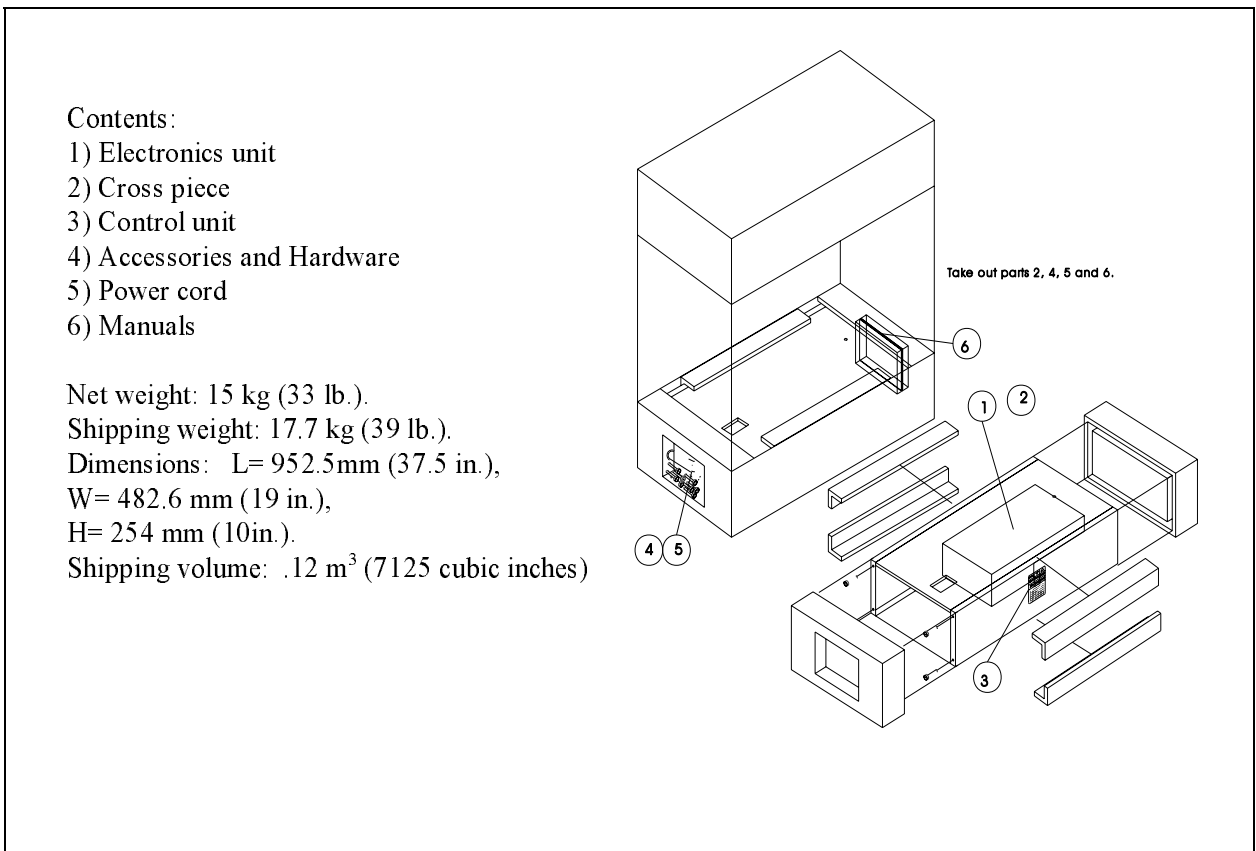

Figure 2-4. Unpacking of the Metor 150 electronics

2.3

**Mechanical
Assembly**

Proceed as follows:

- 1) CHECK THE **50 OR 60 Hz MAINS FREQUENCY SETTING** AND SELECT, IF NEEDED, TO CORRESPOND TO THE LINE FREQUENCY.

The frequency setting is selected by the position of a short circuit plug in the electronics unit, located inside the cross piece (see fig. 2-5).

The setting in use is displayed on the control unit when the power is switched on.

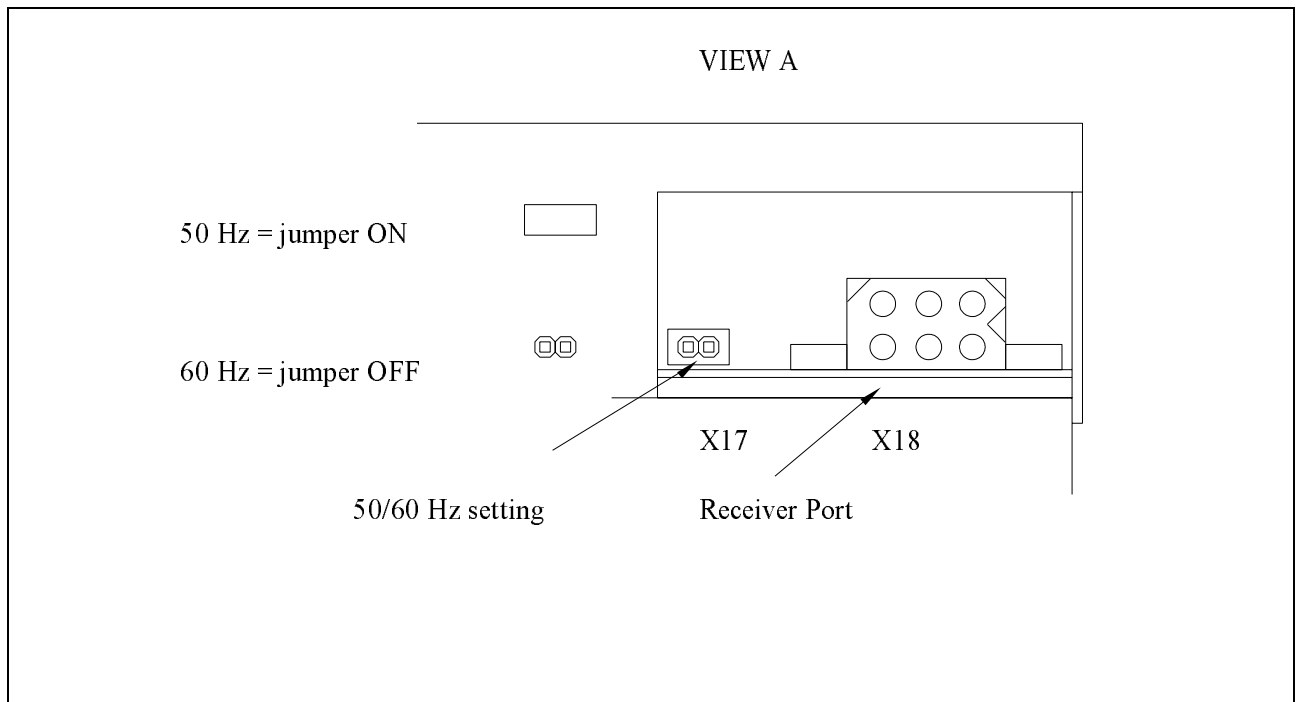

Figure 2-5. The 50/60 Hz setting

- 2) **PLUG THE POWER INPUT CORD TO THE TRANSMITTER PANEL CONNECTOR OR RECEIVER PANEL CONNECTOR.**
This is needed only if the cable outlet from the bottom is used. (see fig. 2-6)

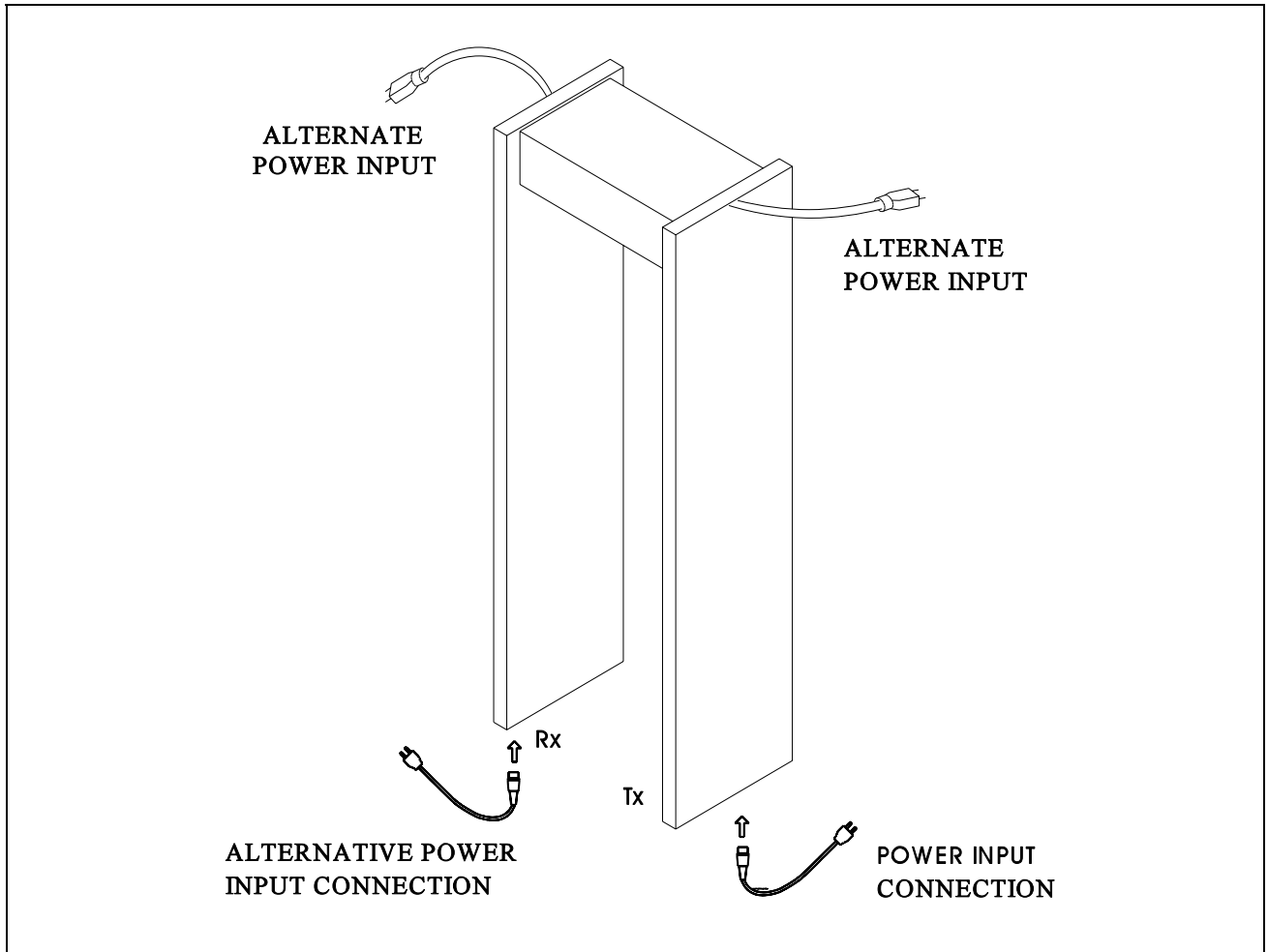

Figure 2-6. **The power cord installation**

If the power input is from the top of the unit, connect the cord before assembling the cross piece. See Figure 2-7 and Section 2.4

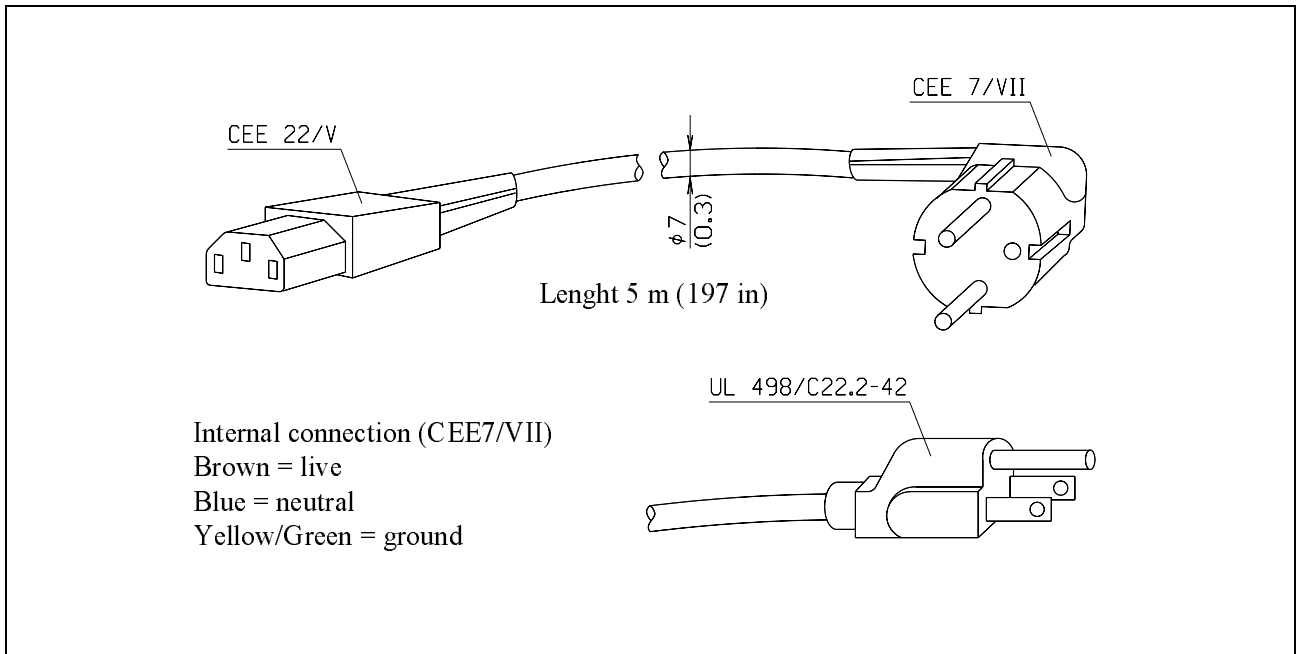

Figure 2-7. Types of power cords and internal connection

3) ASSEMBLE THE COIL PANELS AND CROSS PIECE BY USING THE EIGHT BOLTS. TIGHTEN WITH THE ALLEN KEY. (Note the **equal coil gap** of 762mm (30 inches) between the transmitter and receiver panels at both the top and bottom. The distance between the tops of the two coil panels must be equal to the distance between the bottoms of the two coil panels to ensure uniform sensitivity in the coil area.)

The detector can be anchored to the floor with **four** brackets to ensure the equal coil gap. These brackets are included in the Floor Mounting Kit. For more information, see Figure 2-8, and the assembly instructions included in the Floor Mounting Kit.

The nuts and the allen key are provided.

The Electronics unit is already installed inside the cross piece and **does not require any assembly**.

The cross piece can be mounted either way between the coil panels.

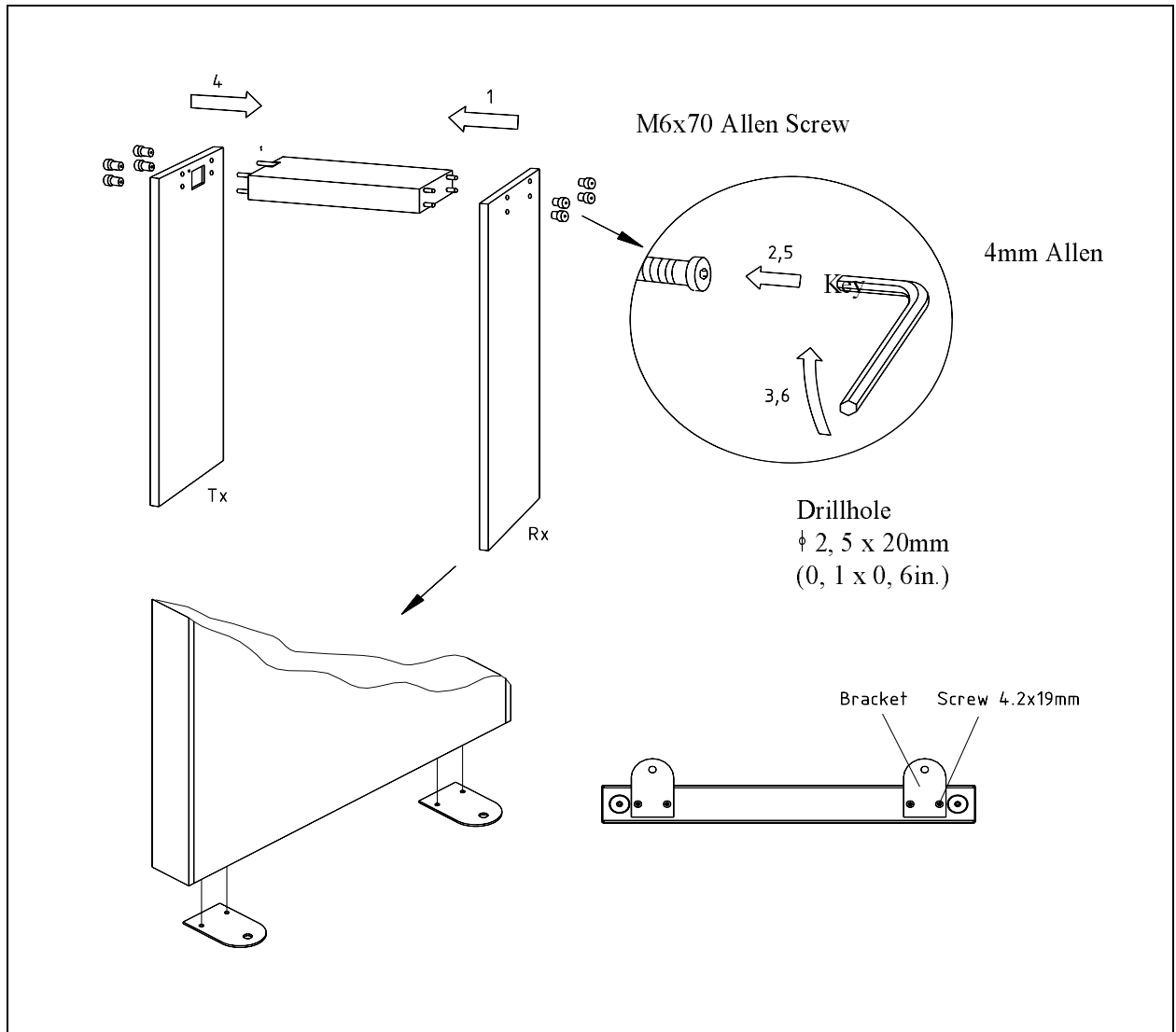

Figure 2-8. Mechanical Assembly of the Metor 150

2.4
Electrical
Connections

Proceed as follows:

- 1) **OPEN THE BOTTOM COVER OF THE CROSS PIECE WITH THE PROVIDED ALLEN KEY.**
- 2) **CONNECT THE TRANSMITTER AND THE RECEIVER CABLES.**

The cable in the coil panels is placed in the connector recess. The connector plug is pulled out and connected to the electronics unit. The cables and connectors are color coded.

- 3) **CONNECT THE CONTROL UNIT.**

The control unit is factory connected directly to the electronics inside the cross piece.

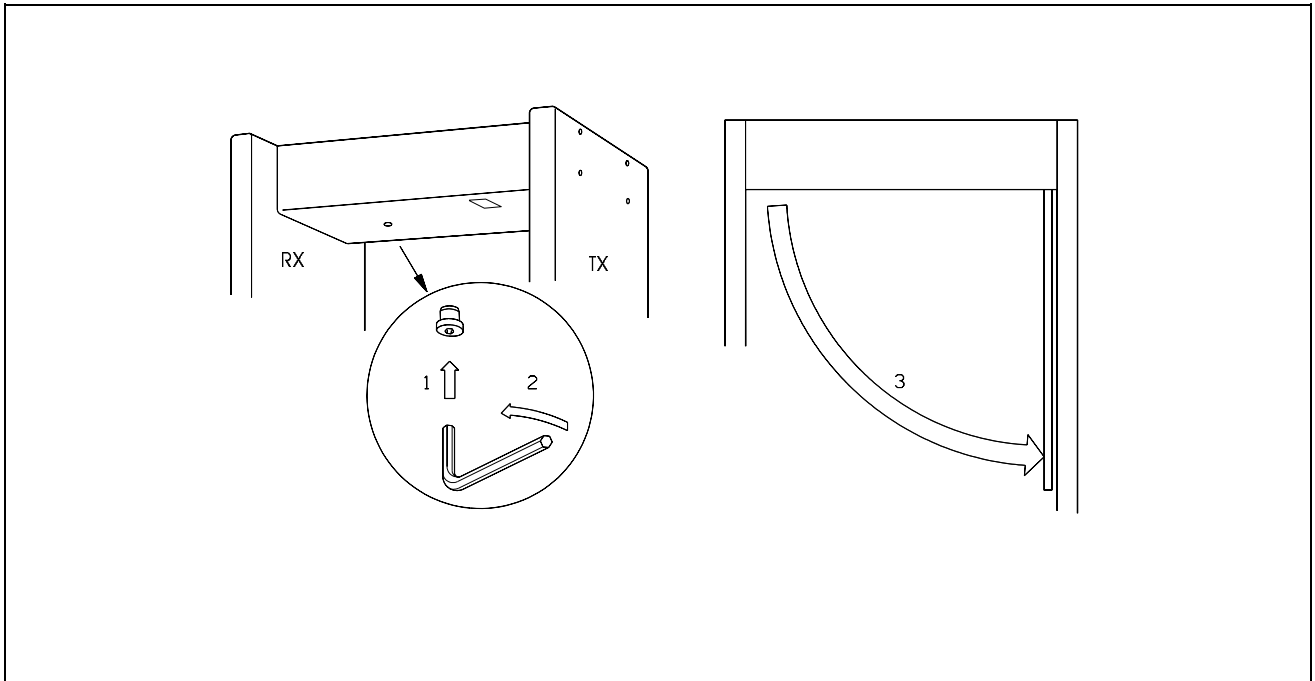

Figure 2-9. **Opening of the bottom cover of the cross piece**

- 4) **CONNECT THE POWER CORD TO THE ELECTRONICS.**

The power cord can be taken in through the top of the cross piece to the bottom of the gate using Transmitter or Receiver power cords. Connect the power cord to the electronics' Mains Input Connector (see Figure 2-11, View A).

5) PLUG **THE POWER INPUT CORD** INTO THE MAINS OUTLET, AT EITHER THE ELECTRONICS OR THE BOTTOM OF THE GATE.

Any mains voltage **between 95 - 250 VAC** is **automatically** accepted and a frequency of **50 or 60 Hz** is **selected manually** (see chapter 2.3).

For electrical safety, a **grounded outlet** should be used in environments classified dangerous in compliance with local regulations.

6) CLOSE **THE BOTTOM COVER** OF THE CROSS PIECE.

The electronics unit also has connections for **the special functions** which are explained in section 4.

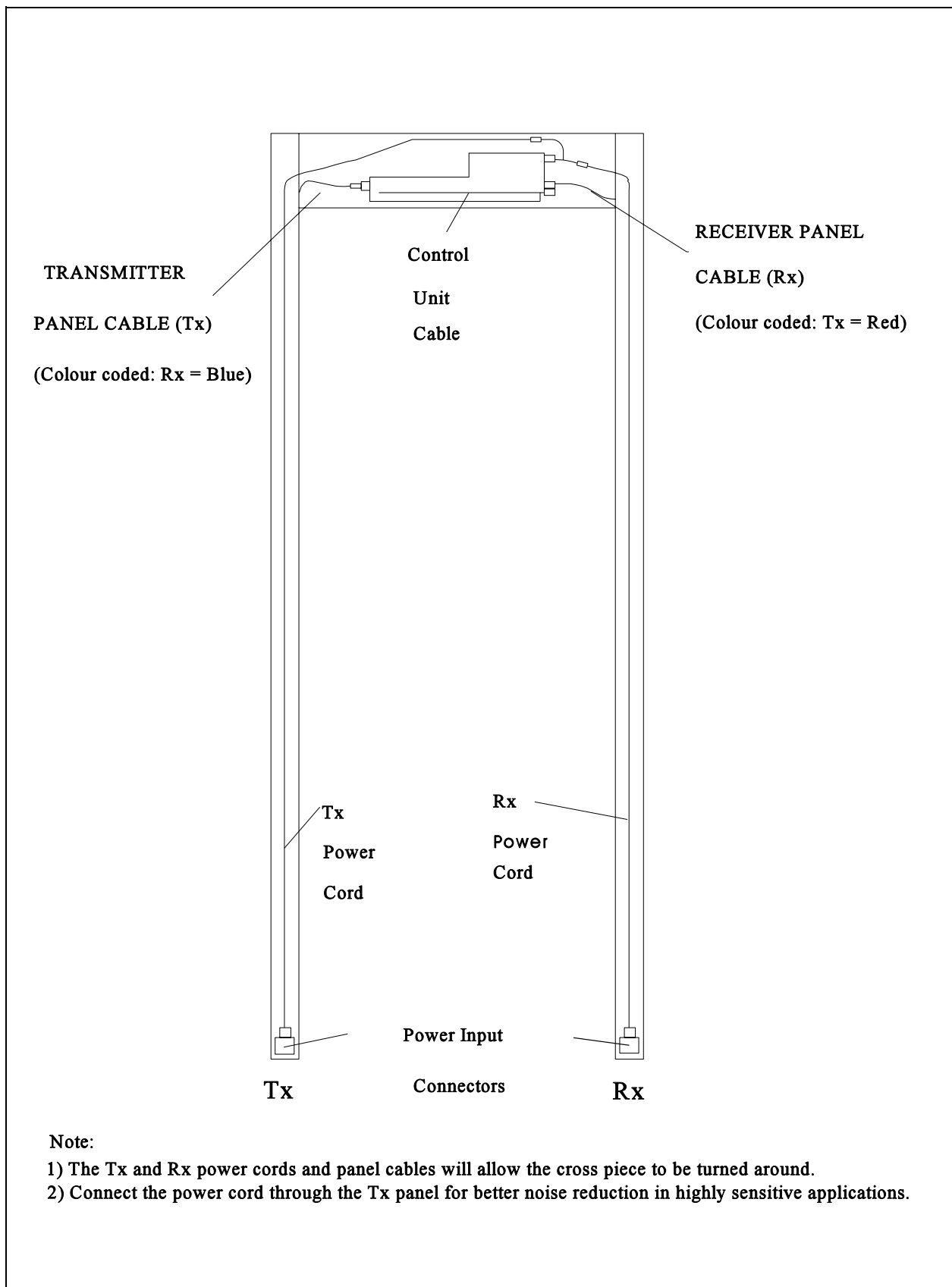
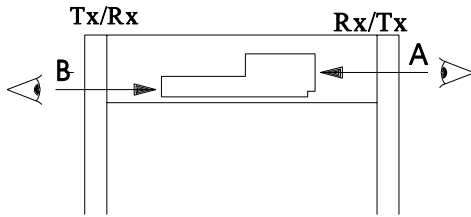

Figure 2-10. Cable routing



Note!:
Connectors are polarized.
Tx/Rx cables are
colour coded.

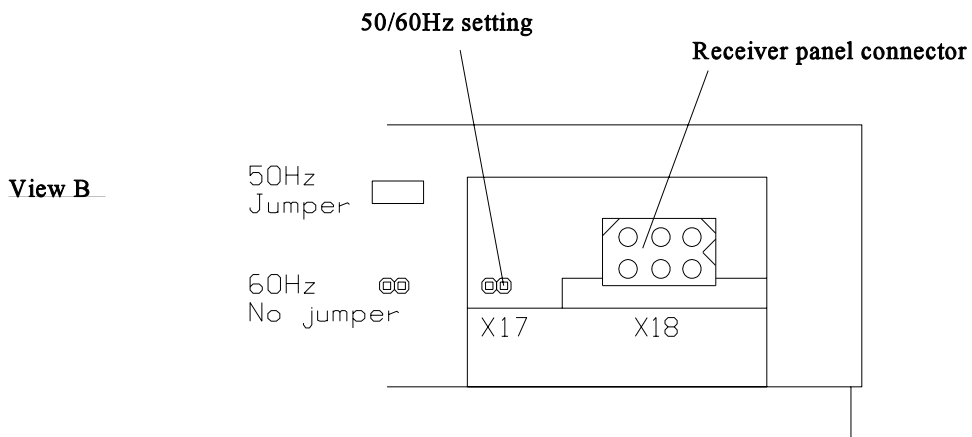
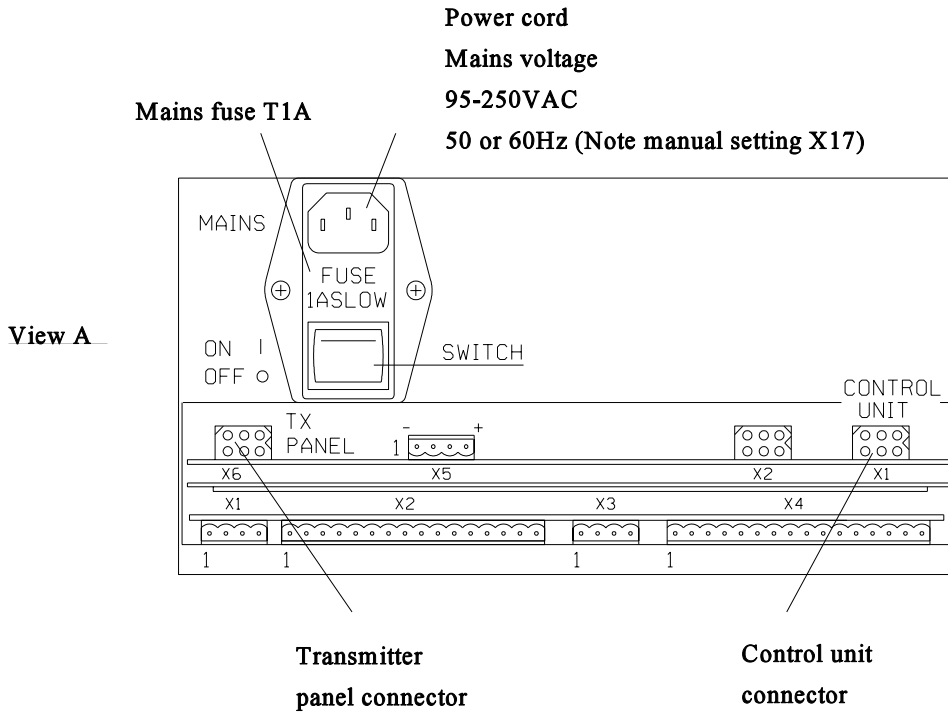

Figure 2-11. The electrical connections and 50/60 Hz setting

SECTION 3

OPERATION

**3.1
Switching
On/Off**

The Meteor 150 can be **switched on when**

- **the mechanical assembling** is finished (see instructions in chapter 2.3),
- **the electrical connections** are made (see instructions in chapter 2.4) and
- **the mains frequency setting** in the electronics unit is set according to the frequency of the local mains, 50 or 60 Hz (see chapter 2.3).

The Meteor 150 accepts **mains voltage between 95-250 VAC automatically and frequency 50 or 60 Hz with manual setting.**

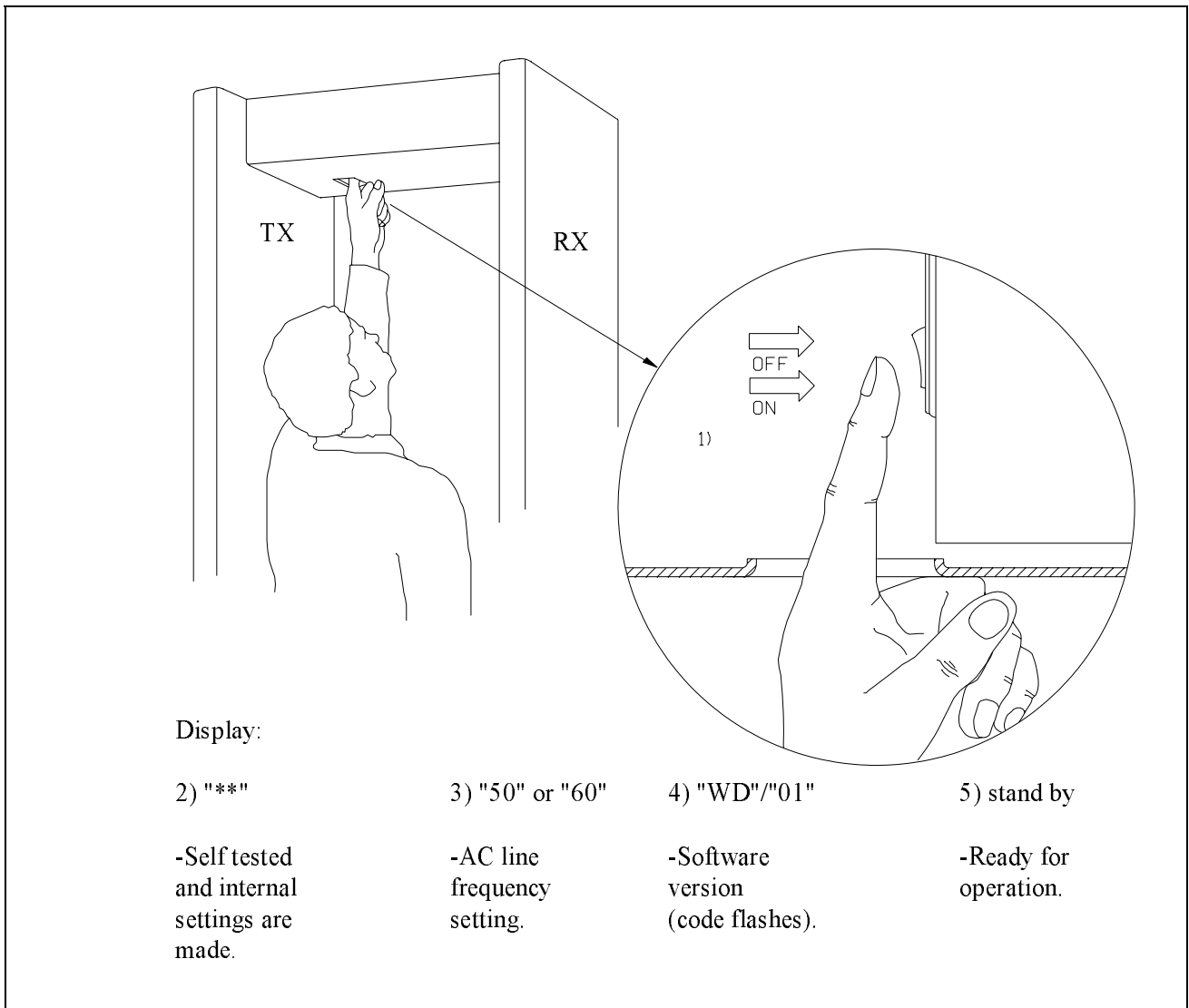

Figure 3-1. **Power switching on**

Proceed as follows:

- 1) **SWITCH THE Metor 150 ON/OFF WITH THE MAINS SWITCH OR BY CONNECTING/DISCONNECTING BATTERY VOLTAGE.**

The Metor 150 goes through a self-checking procedure. During the check, the star figure (**), the mains frequency setting (50 or 60), and the software version code for that particular unit is indicated on the display (for instance WD01). After a period of 20 to 30 seconds, the audible alarm is tested and the green standby light indicates the unit is operating. If any other message is displayed, for instance ER/XX, see chapter 6.3 for the reason.

Before actual use, the system **should be adjusted to suit the application** (see chapter 3.2).

The used adjustments are memorized and they are not lost if power is switched off. When switching on the next time, the same settings will be in use.

3.2 Adjustments

The system comes **factory preset** for mid-range performance, and in so doing provides a good basis to make the final adjustments. For further information, see

- factory settings chapter 3.4.1,
- programming guides in chapter 3.2 and
- discussion about programming in chapter 3.3.

To adjust and check the settings, proceed as follows (for the operation of keypad see the quick reference for settings, fig. 3-3, and the detailed instructions in figures from 3-4 to 3-10):

- 1) CHECK THE **SENSITIVITY** LEVEL AND ADJUST, IF NEEDED.
 - For **manual adjustment** see figures 3-3 and 3-4.
 - **Automatic adjustment** is explained in chapter 3.4.5.
- 2) IF THE SELECTED PROGRAM IS INSUFFICIENT, SELECT A DIFFERENT **PROGRAM**. THEN RECHECK THE SENSITIVITY.
- 3) CHECK, AND ADJUST IF NEEDED, THE **AUDIBLE ALARM VOLUME, TONE AND THE MINIMUM SETTING FOR THE VOLUME**.
- 4) SELECT **AUTOMATIC OR MANUAL RESET**.
- 5) **MODE SETTINGS** ARE SELECTED, IF
 - **two or more detectors** operates close each others, MODE/F setting (see chapter 4.1),
 - **the speed response** is changed to more effectively detect slow or fast moving objects, MODE/L or H settings (see chapter 4.5), or
 - greater **noise attenuation** is needed, MODE/F and MODE/H settings (see chapter 4.5 and 6.4).

The adjustment keypad as well as the light display and the audible alarm of the Metor 150 are located in the control unit.

The control unit has a cable which allows the keyboard to be connected to the electronics unit. The control unit is mounted to the inside of the cross piece.

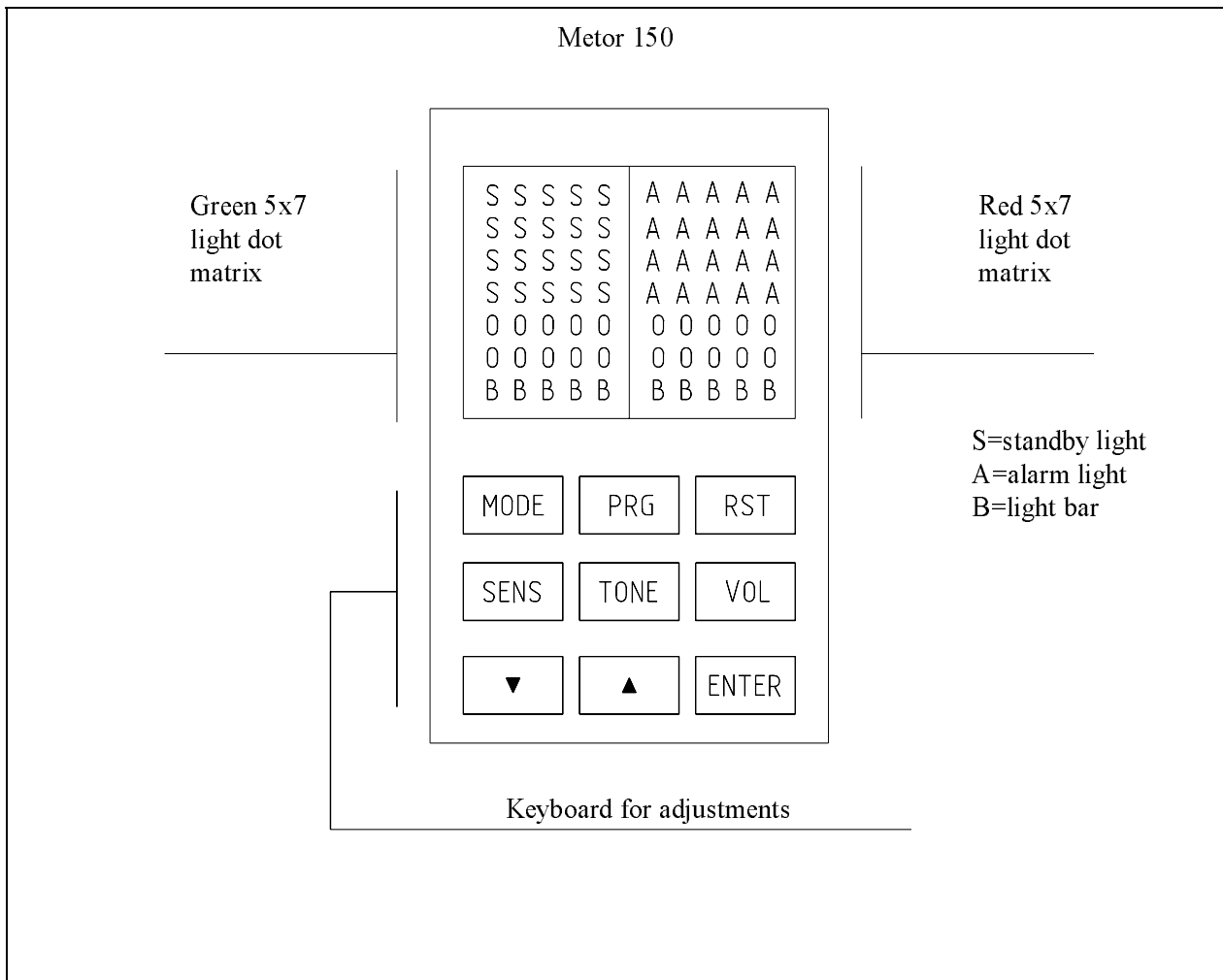

Figure 3-2. The control unit

The display has two 5x7 light dot matrices to monitor the operation of the detector.

- The green upper light area indicates the **standby state** and the red upper light area indicates **the alarm state**.
- The light bar at the bottom of the matrix indicates the **signal amplitude** proportional to the size of the detected metal. When the signal increases from left to right, the alarm occurs in the red section.
- The codes monitored by letters and numbers indicate the **software version, adjustments or condition states** of the Metor 150.

In the standby state only the green lights operate. They go off when the alarm state is activated.

An audible signal can be generated in several ways. Each indicates the state of the detector and has the following meanings:

- **alarm indication** with adjustable volume and tone,
- **indication of the proper key operation**, or
- **indication of keying error** during adjustments

The keypad is used to make adjustments to the unit and there are two setting levels:

- In **operator adjustment mode** only audible alarm volume adjustment and manual reset are operational.
- In **programmer mode** only an authorized person who knows the access code can change the settings. The three keys should be entered in the correct order to enable the operator to make other adjustments except volume and manual reset. After the adjustments, the keyboard should be locked manually by pushing the ENTER key three times. Otherwise, it will be locked automatically within one minute from the last key entry.

The digit access code can be changed. The instructions for modifications and checking the code are in a separate publication. (It has been factory preset to 3 x MODE key.)

Note when making adjustments:

- One press of ▲ or ▼ key generates one step in setting. Repetitive steps are accomplished by constantly pressing the key.
- A keying error is indicated by an intermittent audible signal and, in some cases, also by the error code.
- If the new adjustment is not accepted by pressing the ENTER key, the previous setting remains in operation and the system automatically returns to the standby state after one minute.
- When a new setting is accepted for operation it is memorized under and corresponds only to the program number in use.

























NAME SETTING	OPEN ACCESS CODE (Factory settings: 3xMODE)	SETTING	CLOSE ACCESS CODE
Sensitivity	3x [?]	PRG SENS  or ENTER 	3x ENTER
Program	3x [?]	PRG  or ENTER 	3x ENTER
Alarm volume		VOL  or ENTER 	
Alarm minimum volume	3x [?]	PRG VOL  or ENTER 	3x ENTER
Alarm tone	3x [?]	PRG TONE  or ENTER 	3x ENTER
Automatic/ manual reset	3x [?]	PRG RST RST ENTER	3x ENTER
Mode settings			
-Frequency (F0-F9)	3x [?]	PRG MODE  or ENTER 	4x ENTER
-High speed response (H0-H2)	3x [?]	PRG 2x MODE  or ENTER 	4x ENTER
-Low speed response (L0-L2)	3x [?]	PRG 3x MODE  or ENTER 	4x ENTER

Figure 3-3. Quick reference to settings.

Figure 3-4. Sensitivity adjustment			
ACTION	RESPONSE		NOTE
	Audible	Display	
<div style="border: 1px solid black; padding: 2px; display: inline-block; width: 30px; height: 20px; text-align: center; margin-bottom: 5px;">?</div> 3x	x) 	standby	Enter the access code. 3xMODE key is the factory setting.
<div style="border: 1px solid black; padding: 2px; display: inline-block; width: 30px; height: 20px; text-align: center; margin-bottom: 5px;">PRG</div>		"PG" / "00-xx"	Program number in use. (xx = last no., see chapter 3.3)
<div style="border: 1px solid black; padding: 2px; display: inline-block; width: 30px; height: 20px; text-align: center; margin-bottom: 5px;">SENS</div>		"SE" / "00-99"	Sensitivity setting in use and operational.
<div style="border: 1px solid black; padding: 2px; display: inline-block; width: 30px; height: 20px; text-align: center; margin-bottom: 5px;">▲</div> or <div style="border: 1px solid black; padding: 2px; display: inline-block; width: 30px; height: 20px; text-align: center; margin-bottom: 5px;">▼</div>		"00 -> 99"	Sensitivity increased.
<div style="border: 1px solid black; padding: 2px; display: inline-block; width: 30px; height: 20px; text-align: center; margin-bottom: 5px;">▼</div> or <div style="border: 1px solid black; padding: 2px; display: inline-block; width: 30px; height: 20px; text-align: center; margin-bottom: 5px;">▲</div>		"00 <- 99"	Sensitivity decreased.
<div style="border: 1px solid black; padding: 2px; display: inline-block; width: 30px; height: 20px; text-align: center; margin-bottom: 5px;">ENTER</div>		"SE" / "00-99"	New setting.
<div style="border: 1px solid black; padding: 2px; display: inline-block; width: 30px; height: 20px; text-align: center; margin-bottom: 5px;">ENTER</div> 3x		standby	Adjusted setting is accepted. Ready for operation.
<div style="border: 1px solid black; padding: 2px; display: inline-block; width: 30px; height: 20px; text-align: center; margin-bottom: 5px;">ENTER</div> 3x		standby	Lock the access code.



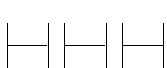
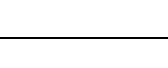

NOTE!

x)  = short "beep"

The sensitivity is adjusted by **carrying a test object** through the detector. This must be done with the object in various orientations and locations in the gate area.

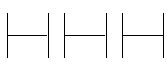
The setting determines **the size of the object** which is detected or harmless objects which are not detected. A higher sensitivity allows detection of smaller metal objects.

Usually the main criteria for detection is the size of metal objects. To some extent the variation of shape and material may alter the limit of detection, as well as the orientation and velocity at which the object is taken through the detector.

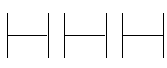







Figure 3-5. Selecting program			
ACTION	RESPONSE		NOTE
	Audible	Display	
<div style="border: 1px solid black; width: 40px; height: 20px; margin: 5px auto; text-align: center; line-height: 20px;">?</div> <p>3x</p>	x) 		Enter the access code. 3xMODE key is the factory setting.
<div style="border: 1px solid black; width: 40px; height: 20px; margin: 5px auto; text-align: center; line-height: 20px;">PRG</div>		"PG" / "00-xx"	Program number in use. (xx = last no., see chapter 3.3)
<div style="border: 1px solid black; width: 40px; height: 20px; margin: 5px auto; text-align: center; line-height: 20px;">▲</div> <p>or</p>		"00 -> xx"	Increased.
<div style="border: 1px solid black; width: 40px; height: 20px; margin: 5px auto; text-align: center; line-height: 20px;">▼</div>		"00 <- xx"	Decreased.
<div style="border: 1px solid black; width: 40px; height: 20px; margin: 5px auto; text-align: center; line-height: 20px;">ENTER</div>		"PG" / "00-xx"	New program fixed.
		"**" / "**"	Program activated.
		"**" / "**"	Wait for a moment (appr. 20 sec.).
		standby	Program accepted.
<div style="border: 1px solid black; width: 40px; height: 20px; margin: 5px auto; text-align: center; line-height: 20px;">ENTER</div> <p>3x</p>		standby	Lock the access code.

NOTE!

x)  = short
"beep"

The Metor 150 has a **number of features that can be used with various programs**.

The detailed operation of programs is explained in chapter 3.3.





Figure 3-6. Audible alarm volume adjustment			
ACTION	RESPONSE		NOTE
	Audible	Display	
	x) 	"VO" / "xx-09"	Enter the access code. 3xMODE key is the factory setting.
		"00 -> 09"	Volume increased.
or			
		"00 <- 09"	Volume decreased.
		"VO" / "xx-09"	New setting.
		standby	Adjusted setting is accepted. Ready for operation.

NOTE!

x)  =
continuous tone.

Volume is adjusted to exceed the background noise level so that **the alarm will be audible for the operator**. For the preset minimum volume level see figure 3-7.

Figure 3-7. Audible alarm minimum volume setting





ACTION	RESPONSE		NOTE
	Audible	Display	
<div style="border: 1px solid black; padding: 2px; display: inline-block;">MODE</div> 3x	x) 		Enter the access code. 3xMODE key is the factory setting.
<div style="border: 1px solid black; padding: 2px; display: inline-block;">PRG</div>		"PG" / "00-xx"	
<div style="border: 1px solid black; padding: 2px; display: inline-block;">VOL</div>	xx) 	"VM" / "01"	Minimum volume setting in use. Minimum volume level is heard.
<div style="border: 1px solid black; padding: 2px; display: inline-block;">ENTER</div>		standby	Ready for operation.
<div style="border: 1px solid black; padding: 2px; display: inline-block;">ENTER</div> 3x		standby	Lock the access code.

NOTE!

x)  = short "beep"

xx)  = continuous tone

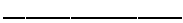
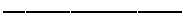
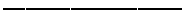
In the operators setting level, **the volume** can be adjusted **between the minimum and the maximum setting**. The minimum setting can be observed only in the access code setting level.







Figure 3-8. Audible alarm tone adjustment			
ACTION	RESPONSE		NOTE
	Audible	Display	
MODE	x) 		Enter the access code. 3xMODE key is the factory setting.
PRG		"PG" / "00-xx"	
TONE	xx) 	"TO" / "01-03"	Tone setting in use and operational. Tone is heard.
▲		"01 -> 03"	
or		"01 <- 03"	Tone lower.
▼		"TO" / "01-03"	
ENTER		standby	Adjusted setting is accepted. Ready for operation.
ENTER 3x		standby	

NOTE!

x)  = short
"beep"

xx)  =
continuous tone

The Metor 150 has three different tones for audible alarm. They can be used to identify the alarms sounded from any adjacent detectors.

Figure 3-9. Selecting automatic (AR) or manual (MR) reset			
ACTION	RESPONSE		NOTE
	Audible	Display	
<div style="border: 1px solid black; padding: 2px; display: inline-block;">MODE</div> 3x	x) 	standby	Enter the access code. 3xMODE key is the factory setting.
<div style="border: 1px solid black; padding: 2px; display: inline-block;">PRG</div>		"PG" / "01-xx"	Program number in use. (xx = last no., see chapter 3.3)
<div style="border: 1px solid black; padding: 2px; display: inline-block;">RST</div>		"AR" or "MR"	The mode in use.
<div style="border: 1px solid black; padding: 2px; display: inline-block;">RST</div>		"MR" or "AR"	New mode.
<div style="border: 1px solid black; padding: 2px; display: inline-block;">ENTER</div>		standby	New setting accepted.
<div style="border: 1px solid black; padding: 2px; display: inline-block;">ENTER</div> 3x		standby	Lock the access code.

NOTE!

x)  = short
"beep"

The Metor 150 has automatic or manual reset for alarm indications.

If **automatic reset** is selected for operation, the duration of the alarm signal before reset is proportional to the size of the detected metal object. The alarm time is from 0.5 to a few seconds.

In **manual reset** mode, detection generates a constant alarm which is reset manually by pushing the RST key.

Figure 3-10. Selecting mode setting

ACTION	RESPONCE		NOTE
	Audible	Display	
<p>MODE</p> <p>3x</p>	<p>x)</p> <p> </p>	standby	Enter the access code. 3xMODE key is the factory setting.
PRG		"PG" / "00-xx"	Program number in use. (xx = last no., see chapter 3.3)
<p>MODE</p> <p>if needed</p>		"F" / "0-x"	Operation frequency mode in use. X=highest setting, see text below.
<p>MODE</p> <p>if needed</p>		"H 0 - 2"	Signal filtering mode in use for fast moving objects. 0=slow, 1=norm, 2=high.
MODE		"L 0 - 2"	Signal filtering mode in use for slow moving objects. 0=slow, 1=norm, 2=high.
<p>▲</p> <p>or</p>		"? 0 -> x"	Increase. ? = F, H or L.
▼		"? 0 <- x"	Decrease.
ENTER		"? 0 - x"	New mode is fixed. (Other mode can be set with MODE key).
ENTER		"? 0 - x"	Mode is accepted.
ENTER		standby	Mode accepted.
<p>ENTER</p> <p>3x</p>		standby	Lock the access code.

Mode settings are needed in **special operations** such as:

- **Multiple array operation** (see chapter 4.1) where different operation frequencies are used (MODE F);
- **Object speed response** (see chapter 4.5) is made with filter selection (MODE/L and H).
- **External interference level** is minimized by testing operation with MODE/F settings and if needed, also, by using MODE/H1 or H0 setting.

The Metor 150 software is provided with the ten operation frequencies.

3.3
Program
Selection

The Metor 150's detector capabilities have been determined with **different user selectable programs**. They include **detection programs** which select different detection parameters to use (see this chapter).

In all programs, some **features can be adjusted by the user**. When a program is selected, the settings previously set for that particular program will be in use. Settings must be made for each program.

3.3.1
Software
version
WD01 (2.20)

The first two programs in each group has been optimized to meet the detection requirements of that group as well as possible. The third program in each group has much the same detection features as the PG06 of the Metor 120 with the SD06 software (a little less sensitive).

Different authorities have a little different detection requirements that may change from time to time. The idea behind the grouping is first to make sure that the Metor users have a set of reliable detection programs to select. Secondly the frame of the program set will be kept as much unchanged as possible when modifications of detection programs of certain group are necessary.

Programs PG15 to PG20 form a set of material selective programs and are intended for applications where detection of certain metal type is important.

Figure 3-11. Programming guide for M150 / WD01 (2.20)				
GROUP	PG:	DISCRIMIN. OF LEGITIMATE ITEMS	EM-NOISE REDUCTION	REDUCTION OF EFFECT OF GATE VIBRATION
US/ airport	00	high	highest	lower
	01	high	high	high
	02	lower	lower	highest
CANADA	03	high	highest	lower
	04	high	high	high
	05	lower	lower	highest
GERMANY	06	high	highest	lower
	07	high	high	high
	08	lower	lower	highest
UK	09	high	highest	lower
	10	high	high	high
	11	lower	lower	highest
US/ govmnt	12	high	highest	lower
	13	high	high	high
	14	lower	lower	highest
Material selective programs:				
FE 15			highest	lower
AL 16			highest	lower
SS 17			highest	lower
PB 18			highest	lower
Ferrite/u-metal 19			highest	lower
FE/AL/SS20			high	high

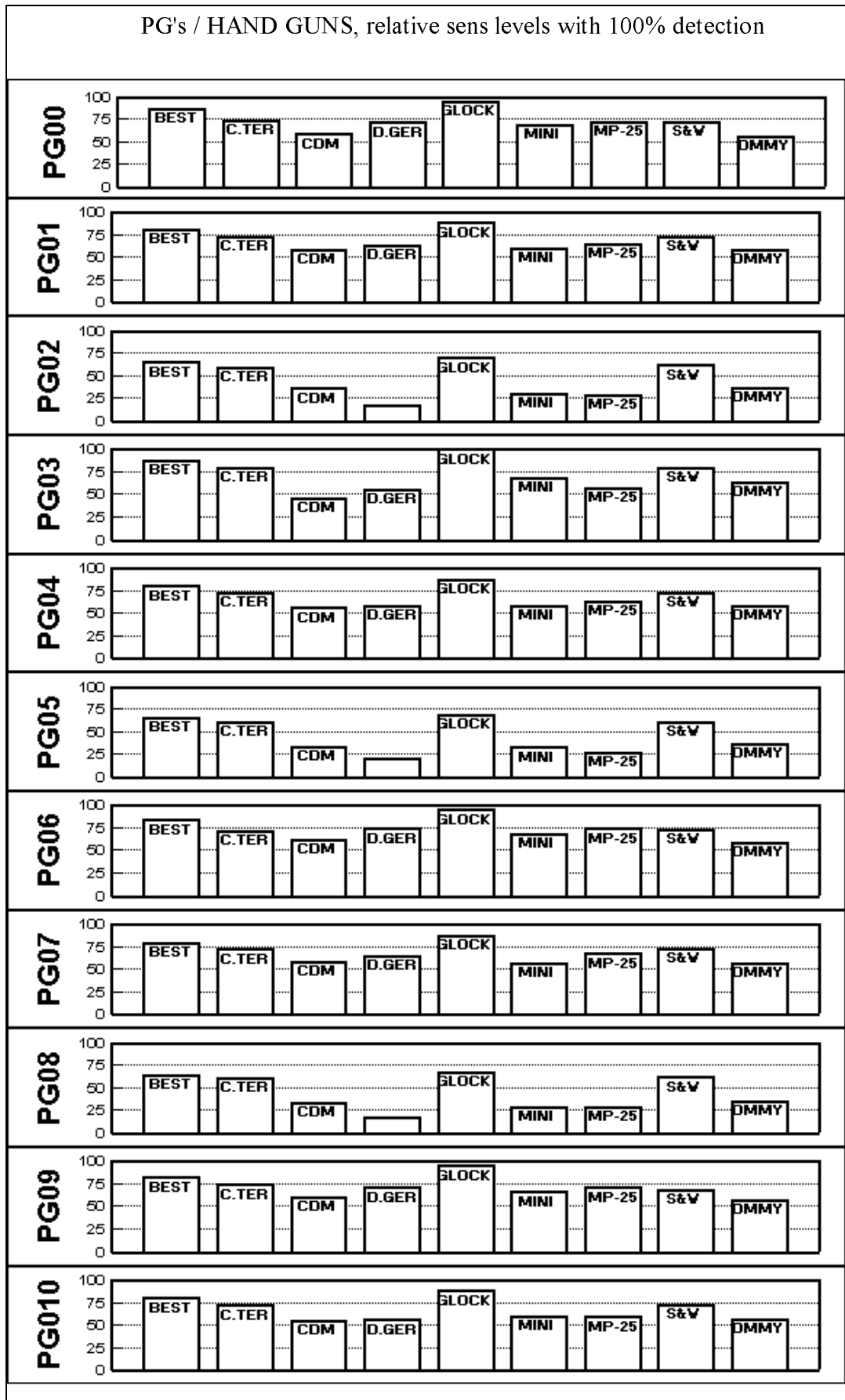

Figure 3-12. next page ...

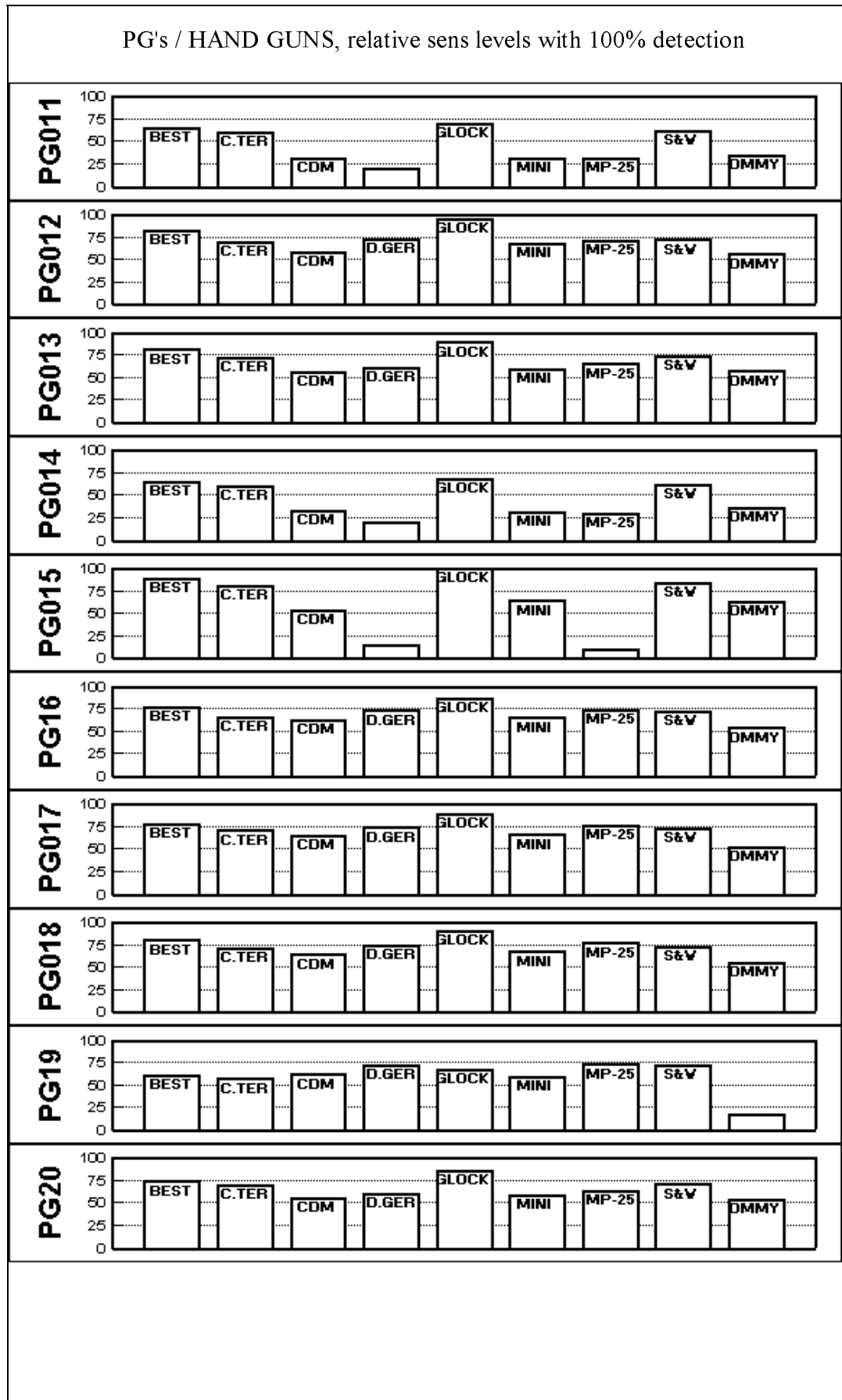

Figure 3-12. next page ...

Meter 150, relative detection capability

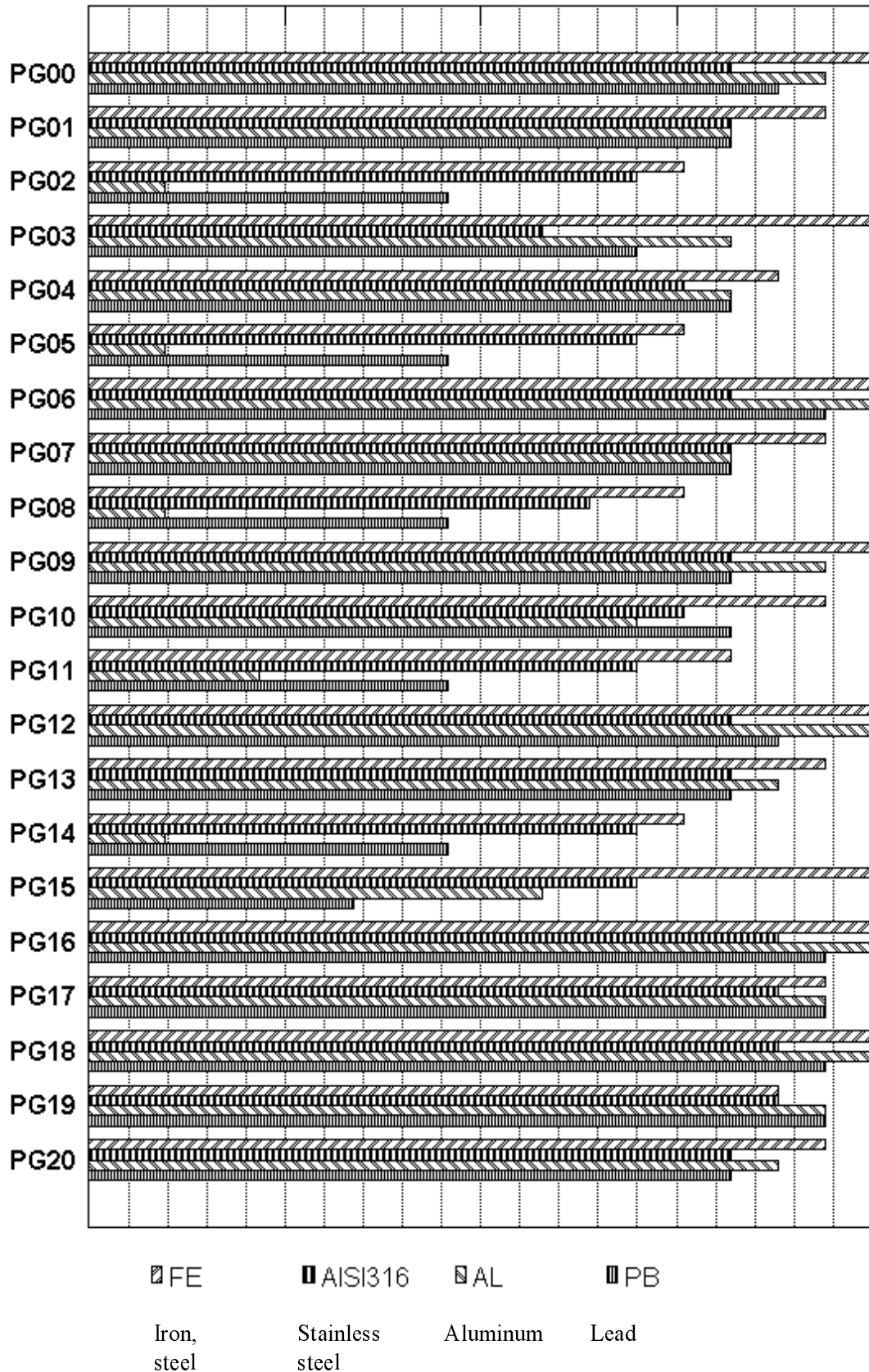

Figure 3-13. next page ...

NOTES!

- TEST CONDITIONS:
- Test objects metal cylinders (dia=length):steel (Fe 37), stainless steel (AISI 316), aluminum and lead.
 - Test place: middle of the gate.
 - Test setup: MELS 2230.2, MCLS 2453.
 - Settings: SE/90, factory settings.

Figure 3-13. **Programming guide for M150 / WD01 (2.20)**

3.3.2

**Detection
Programming**

The following discussion will focus on the proper **procedure to find the right settings** for your particular application. A detailed discussion, describing how to make each adjustment, will follow.

**Reference
object**

When beginning to fine tune the metal detector to the particular installation site, the programmer must determine the level of security desired by first deciding which object(s) shall be detected. Once a reference object is chosen, it should be used exclusively in the calibration procedure to ensure consistency of performance.

Clothing

The person performing the test should be wearing whatever clothing will be allowed minus any unnecessary metal objects.

Programming

The Metor 150 has several programs to choose from which offer different detection capabilities. Figures from 3-12 to 3-13 indicates which programs may offer the best performance when detecting certain types of metal objects.

The relative sensitivity for a selection of hand guns is shown in fig. 3-12. The bar graph indicates the sensitivity level with 100% detection for the specific test object.

The relative material sensitivity with steel, stainless steel, and aluminum is shown in fig. 3-13. The longer the bar graph, the better detection for smaller metal objects. Detection of aluminum is almost similar to other nonferrous alloy metals such as copper, brass, gold, and silver.

Choose a program to begin testing. All the adjustments made within a particular program (sensitivity, etc.) affect only that program. If another program is selected, the detection programming procedure will have to be redone.

The metal detector is factory preset to a medium level of sensitivity (see chapter 3.4.1). This is a good place to start. Use the reference object to test the sensitivity setting by carrying the object through the gate. Repeat this test with the object carried in different hiding places relative to your application. Increase the sensitivity, if necessary, to ensure detection in all locations. See also the object speed response, chapter 4.5.

It is advisable to go through this procedure with all programs in the beginning to see which one works best for your application. It is time-consuming but well worth the effort, both as a way to become familiar with the equipment and to obtain the best results.

3.4
Test and
Setting
Programs

The test and setting programs include some special features which typically effect the detection parameters in the detection programs (see chapter 3.3).

3.4.1
PG 55
Factory Settings

Choose a program to begin testing. All the adjustments made within a particular program (sensitivity, etc.) affect only that program. If another program is selected, the detection programming procedure will have to be redone.

The metal detector is factory preset to a medium level of sensitivity (see chapter 3.4.1). This is a good place to start. Use the reference object to test the sensitivity setting by carrying the object through the gate. Repeat this test with the object carried in different hiding places relative to your application. Increase the sensitivity, if necessary, to ensure detection in all locations.

It is advisable to go through this procedure with all programs in the beginning to see which one works best for your application. It is time-consuming but well worth the effort, both as a way to become familiar with the equipment and to obtain the best results.

The 150 is factory preset for mid-range performance. These settings are a good basis for the final values which are made according to the application by using a test object as a sensitivity criteria.

PG	SE	TO	VO	VM	F	H	L	AR/MR
00	32	1	1	1	9 (B)	2	1	AR
01	44	1	1	1	9 (E)	2	1	AR
02	65	1	1	1	9 (9)	2	1	AR
03	32	1	1	1	9 (B)	2	1	AR
04	44	1	1	1	9 (E)	2	1	AR
05	65	1	1	1	9 (9)	2	1	AR
06	32	1	1	1	9 (B)	2	1	AR
07	44	1	1	1	9 (E)	2	1	AR
08	65	1	1	1	9 (9)	2	1	AR
09	32	1	1	1	9 (B)	2	1	AR
10	44	1	1	1	9 (E)	2	1	AR
11	65	1	1	1	9 (9)	2	1	AR
12	32	1	1	1	9 (B)	2	1	AR
13	44	1	1	1	9 (E)	2	1	AR
14	65	1	1	1	9 (9)	2	1	AR
15	40	1	1	1	9 (B)	2	1	AR
16	40	1	1	1	9 (B)	2	1	AR
17	48	1	1	1	9 (B)	2	1	AR
18	40	1	1	1	9 (B)	2	1	AR
19	40	1	1	1	9 (B)	2	1	AR
20	58	1	1	1	9 (B)	2	1	AR
<p>SENSITIVITY SETTING's to detect the following objects:</p> <ul style="list-style-type: none"> - PG00 - PG14: NAA mini revolver cal.22 in waist high, barrel down and grip right. - PG15 - PG20: dia 35 mm Fe cylinder. <p>TEST AND SETTING PROGRAMS:</p> <ul style="list-style-type: none"> - PG56, 64, 66: off. 								
<p>Figure 3-14. Factory settings for M150 / WD01 (2.20)</p>								

3.4.2
PG 56
Coils
Condition
Monitoring
"Cm"

In normal operation the coils condition is controlled by an internal fault diagnostics procedure. If any malfunction is found the error message "ER/22" is shown.

PG 56 inhibits the coils condition monitoring when the display shows "Cm/of". Then a wider coil gap as standard or some special type of shield plates in the coil panels can be used without error message, which otherwise is probably shown. The next PG 56 enter will switch on the monitoring and "CM/on" is shown.

3.4.3
PG 63
Noise
Measurement
Mode
"NS"

The external noise level is to show by the numeric display. The feature helps to **optimize the installation site with a minimum noise level.**

In this function the receiver coil measures the noise level one minute and the maximum signal level is displayed. The scale of the reading is from 0 to 99 where 50 is the first reading over alarm level. The sensitivity setting effects in normal way to signal level.

Using the noise measurement mode:

- 1) Select program 63.
- 2) After a while "***" on display indicates the measurement function. The measuring takes appr. 1 minute.
- 3) "NS/xx" (xx = reading of noise signal) display shows the noise level.
- 4) The normal metal detection operation continues automatically.

3.4.4
PG 64
Programmable
Reset Time
"AT"

Alarm reset time can be reduced to minimum ("fast reset") to **optimize the traffic flow**.

In normal operation reset time is from 0.5 sec to several seconds depending on the detected object size. With "fast reset" the time can be programmed between 0.3 sec to 2.8 sec. As a factory setting the function is off and the reset time is 0.8 sec (T5 on display).

Using programmable reset time (with a preset reset time):

- 1) To set on: Select program 64. Display shows "AT/on".
- 2) To set off: Select program 64. Display shows "AT/off".

Setting the reset time:

- 1) Select program 65.
- 2) Press keys <PG> and <MODE>. Display shows the preset value "Tx" (x = value of reset time).
- 3) Use <▲> or <▼> keys to select new setting. See table below for the corresponding display.

DISPLAY	T0	T1	T2	T3	T4	T5	T6	T7	T8	T9	TA	TB	TC
TIME (sec)	0.3	0.4	0.5	0.6	0.7	0.8	0.9	1.0	1.1	1.2	1.3	1.4	1.5
DISPLAY	TD	TE	TF	TG	TH	TI	TJ	TK	TL	TM	TN	TO	TP
TIME (sec)	1.6	1.7	1.8	1.9	2.0	2.1	2.2	2.3	2.4	2.5	2.6	2.7	2.8

- 4) Press 5x <ENTER> to accept the new setting and to return to metal detection.

**3.4.5
PG 66
Automatic
Sensitivity
Adjustment**

Sensitivity is adjusted automatically by walking through the gate with a reference metal object that is needed to detect.

Adjustment is done according to the preset no. of walks and for the minimum signal. As a factory setting the function is off and no. of walks is 5.

Using the automatic sensitivity adjustment:

- 1) Select program 66.
- 2) When the **display shows "IN"** for a short moment a person **should walk through the gate with the reference object.** "IN" is displayed as many times as preset no. of walks.

NOTE! There should be **as many walks** with metal object as **"IN" displays.** Otherwise, the sensitivity setting is done to maximum.

- 3) The new sensitivity setting is shown "SE/xx" and the normal operation is continued automatically.

Setting the quantity of walks:

- 1) Set program 61.
- 2) Press key <PG> and <MODE>. Display shows the preset value "Wx" (x = no. of walks).
- 3) Use <▲> or <▼> keys to select new setting. See table below for the number of walks corresponding the display.

DISPLAY	W1	W2	W3	W4	W5	W6	W7	W8	W9	WA	WB	WC	
WALKS	1	2	3	4	5	6	7	8	9	10	11	12	
DISPLAY	WD	WE	WF	WG	WH	WI	WJ	WK	WL	WM	WN	WO	WP
WALKS	13	14	15	16	17	18	19	20	21	22	23	24	25

- 4) Press 5 x <ENTER> key to accept new setting and to return to metal detection.

SECTION 4

TYPES OF OPERATIONS AND OPTIONS

**4.1
 Multiple
 Array
 Operations**

Multiple array operation is used when two or more Metor 150 **metal detectors operate close to each other**. Depending on the sensitivity, program settings and distance between detectors, the devices may create **mutual interference**.

Specific operation frequencies are probably needed when the distance between detectors is **10 m (33 ft.)** or less. (Specific frequencies are used in place of synchronization cables). The absolute **minimum distance** between detector gates is **0.5 m (20 in.)**. In practice the distance requiring special action is best determined experimentally case by case.

Operation frequencies are selected with **mode settings F0 - F9**. In the nearby detectors the frequencies are set to different values. In some cases the best combination should be tested case by case.

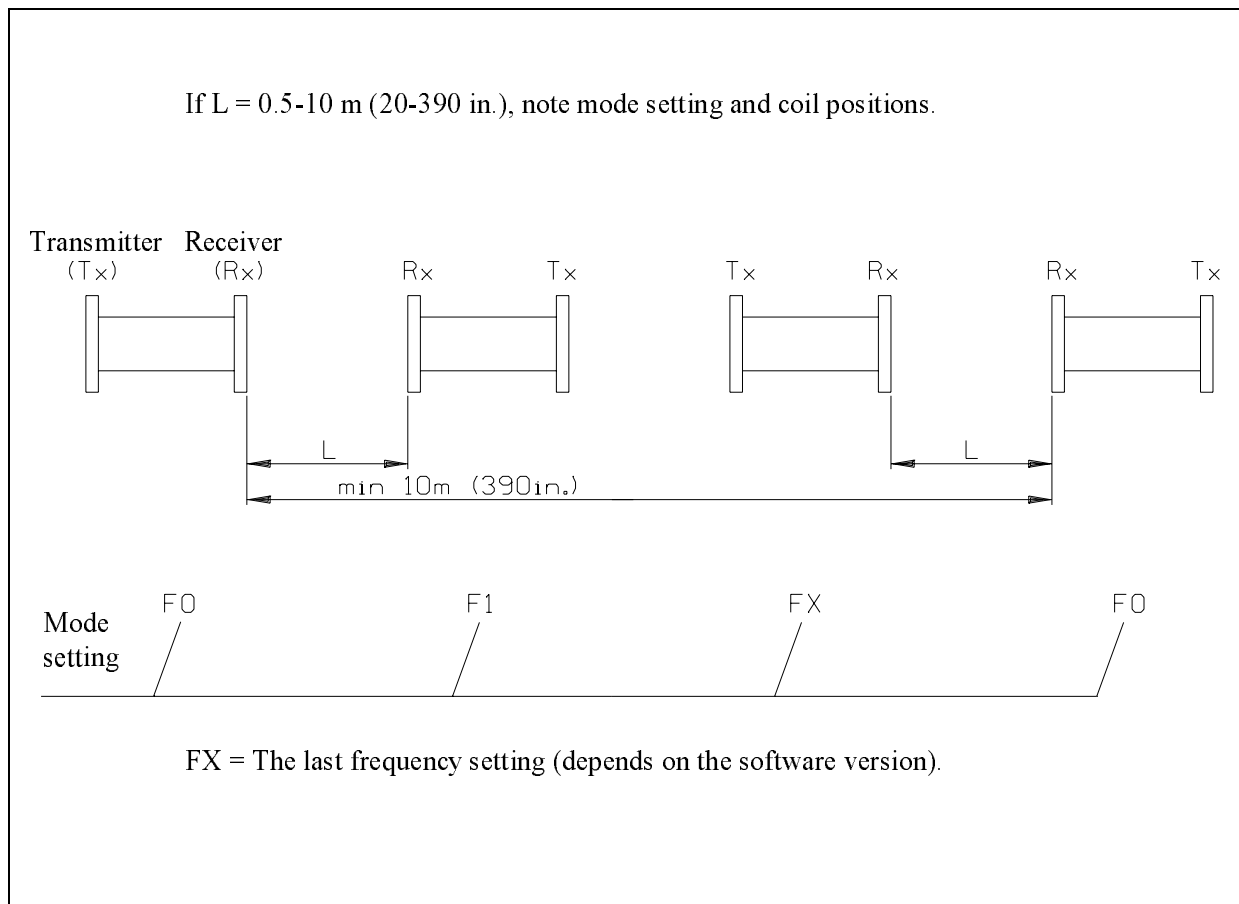

Figure 4-1. **The multiple array operation of the Metor 150**

4.2 Alarm Contact

The Meteor 150 has an alarm relay to control external devices. It can be used to monitor the alarms by controlling external audible and lamp signals.

The relay is a voltage free change over contact with fuse protection (T2A fuse on MMCU board) and screw terminal/plug-in connector in the electronics box. The relay operates when the Meteor 150 is in the alarm state.

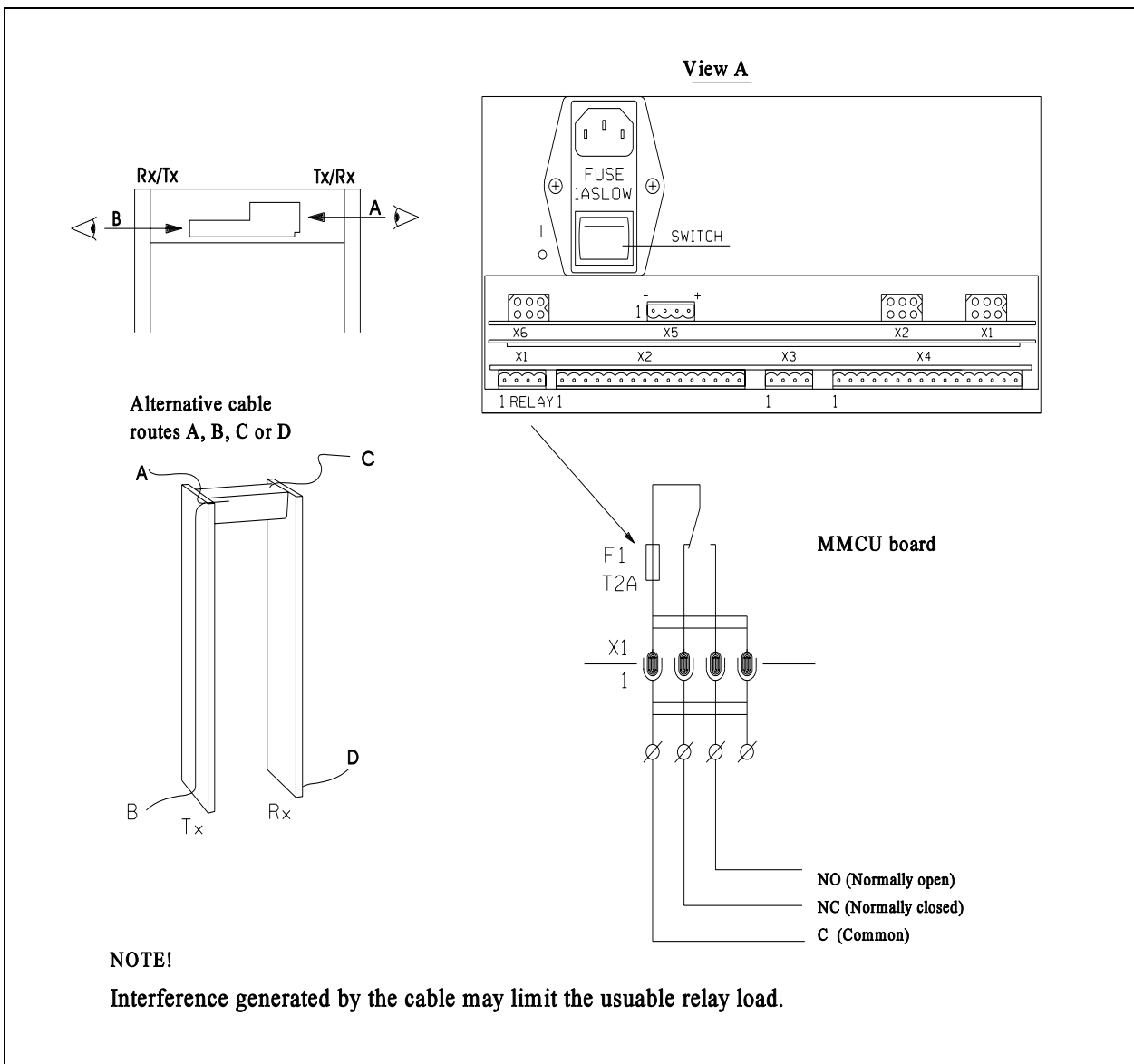

Figure 4-2. The connection of alarm relay

**4.3
Keyboard
Inhibition**

The keyboard inhibition prevents the operation of the keyboard of the control unit. In this way unauthorized persons are prevented from making any adjustments to the Metor 150.

The operation is controlled by a normally open contact (N.O.) which is connected to a digital input. This switch can be located remotely or to terminal block X4. The keyboard inhibition is active when the contact is closed.

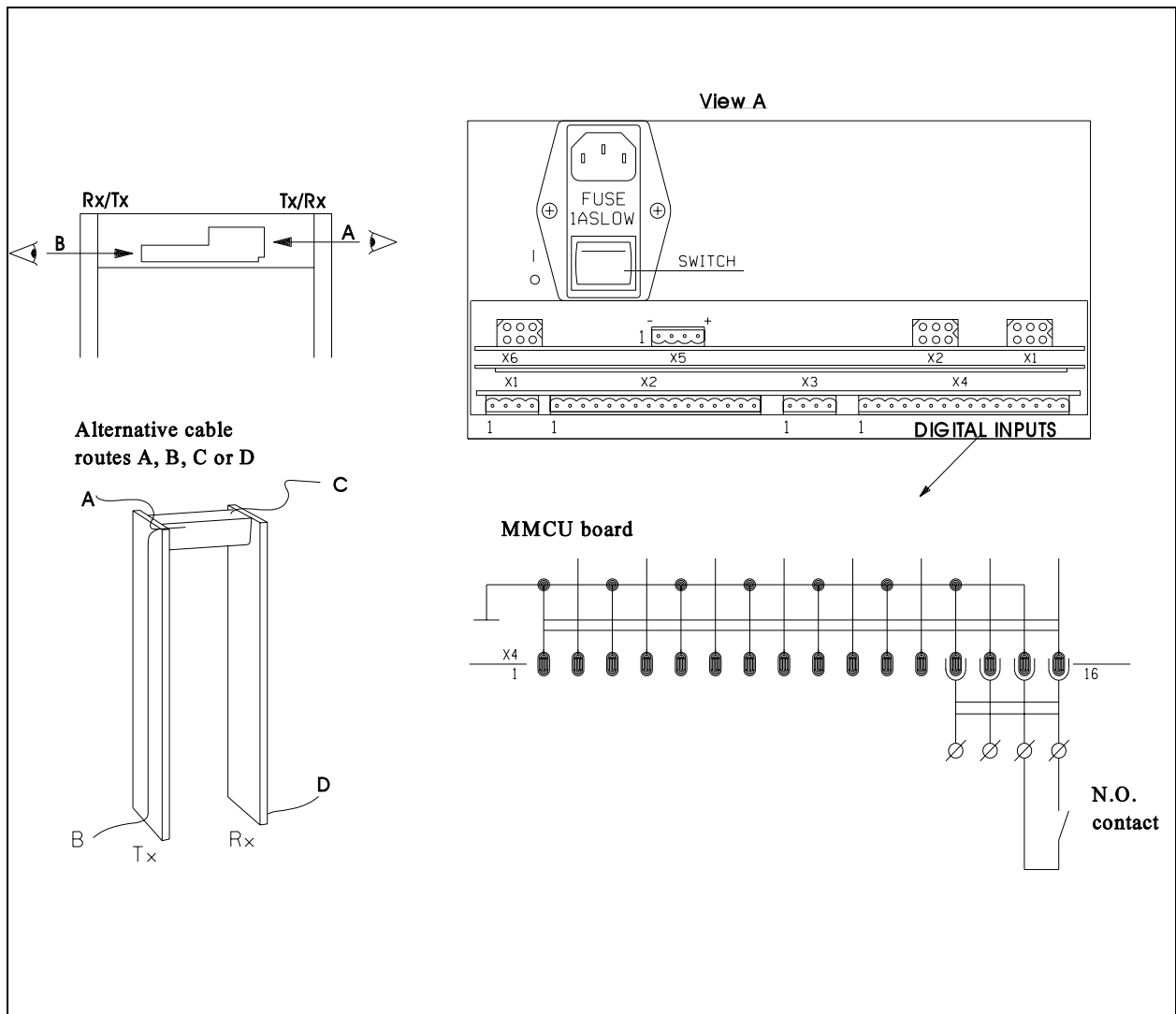

Figure 4-3. The connection of keyboard inhibition

**4.4
Battery
Backup**

The Meteor 150 can be powered by a 24 VDC battery which provides **automatic and uninterrupted operation in the case of a mains voltage failure.**

The 24 VDC is switched on automatically when the mains voltage drops below the minimum specified threshold value and switched off when the mains voltage returns. The Meteor 150 does not have battery charge circuit. A separate battery charger must be used.

Battery operation is active when the DC voltage is connected to the electronics unit despite the position of the mains switch. **The only way to turn off the system is to disconnect the battery cable.**

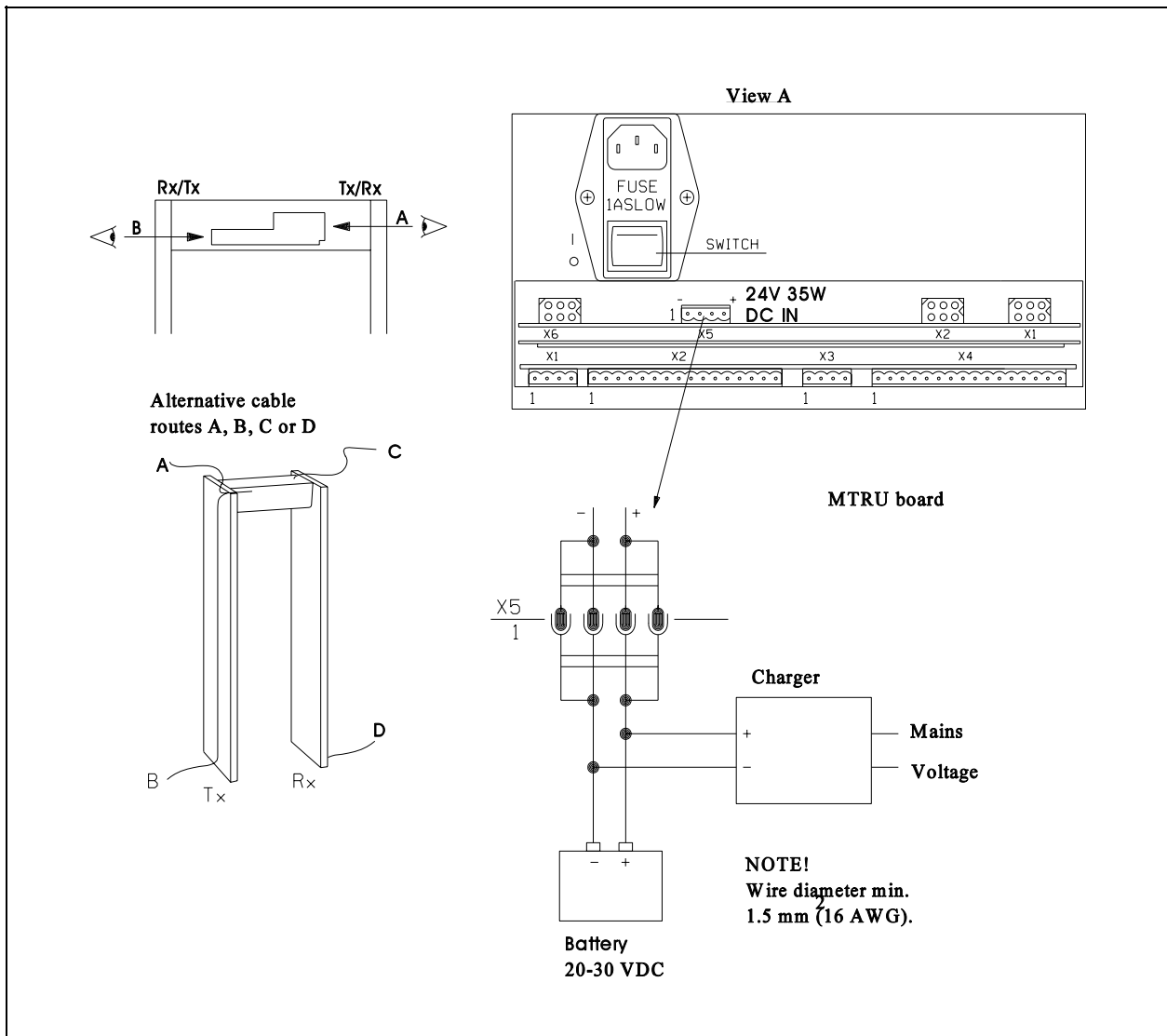

Figure 4-4. The connection of battery voltage

4.5
Display Unit

Physically the display unit has a similar appearance to the control unit, but the operation differs. **The display and the audible functions are the same as in the control unit, but the keyboard does not operate at all.** The display and the audible signal operates as explained in chapter 3.2.

The control unit must be connected to the electronics unit when the display unit is used.

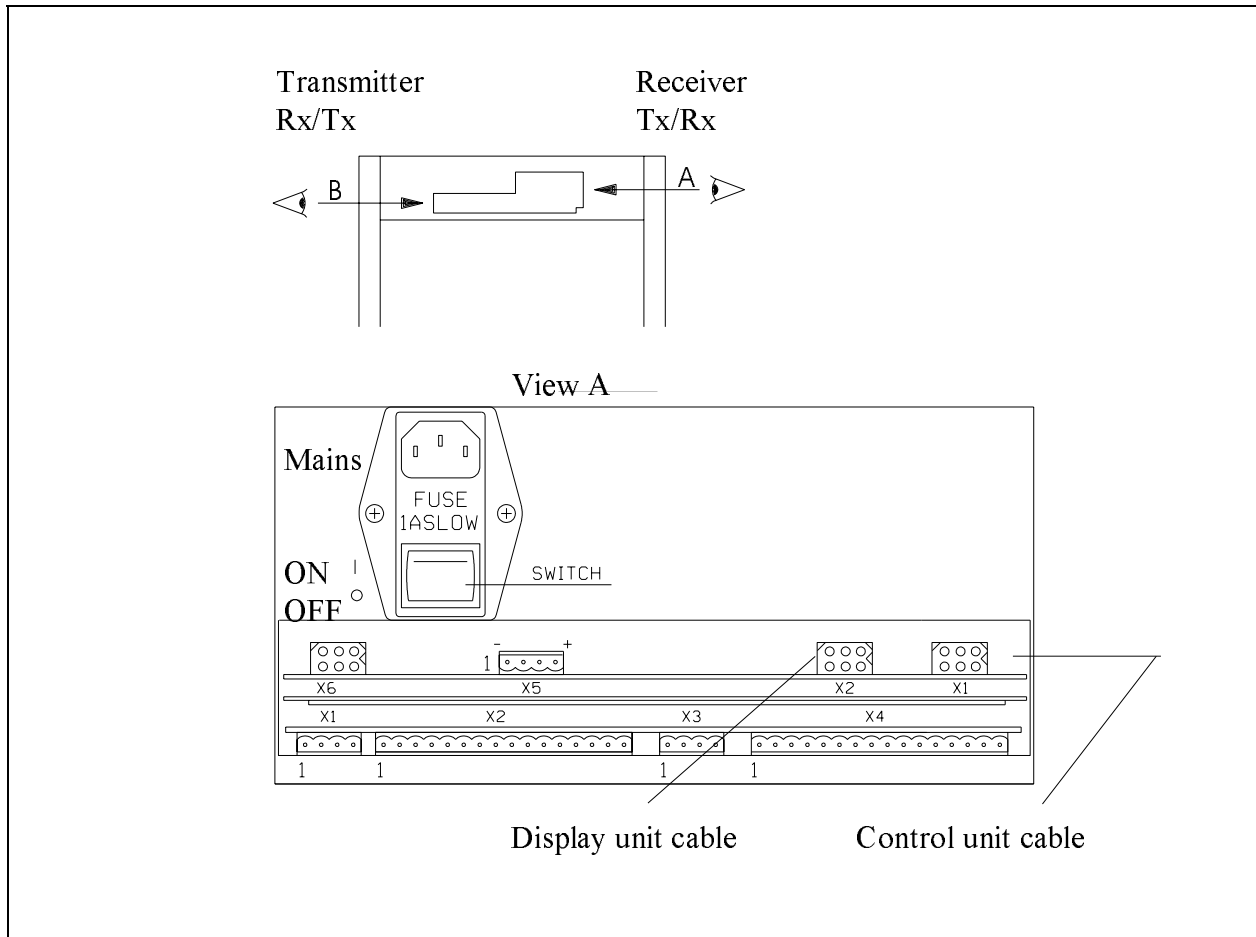

Figure 4-5. Installation of the display

4.6 Object Speed Responses

Object speed relates to the speed at which a person walks through the gate. Object speed response is the metal detector's **ability to maintain a consistent level of sensitivity over a wide range of walking speeds.**

During your detection programming procedure, if you alarm while carrying the test object through the gate, say, two out of three passes (with the object in the same position), it may be due to a variation in your walking speed. We can compensate for this variation by widening the range of the object speed response.

Adjust the "L" and/or "H" filter one increment at a time and retest by sequencing the "L" filter from L2 to L1 or L0 and, if necessary, the "H" filter from H0 to H1 or H2. There are nine different combinations you can try to obtain the best results. L settings effect to slow speeds and H settings effect to high speed.

The upper range of the Object Speed Response (indicated by the "H" setting) is also used to reduce the effects of electrical interference. The lower the "H" setting (H0), the better the equipment will attenuate electrical interference.

The object speed response is modified by MODE/H and L settings (see chapter 3.2).

Figure 4-6. Setting guide for object speed response

MODE	SPEED RESPONSE			INTERF. ATTENUATION			MEANING
	slow	norm	fast	good	norm	low	
H0	X			X			High end setting.
H1		X			X		
H2			X			X	
L0	X						Low end setting.
L1		X					
L2			X				

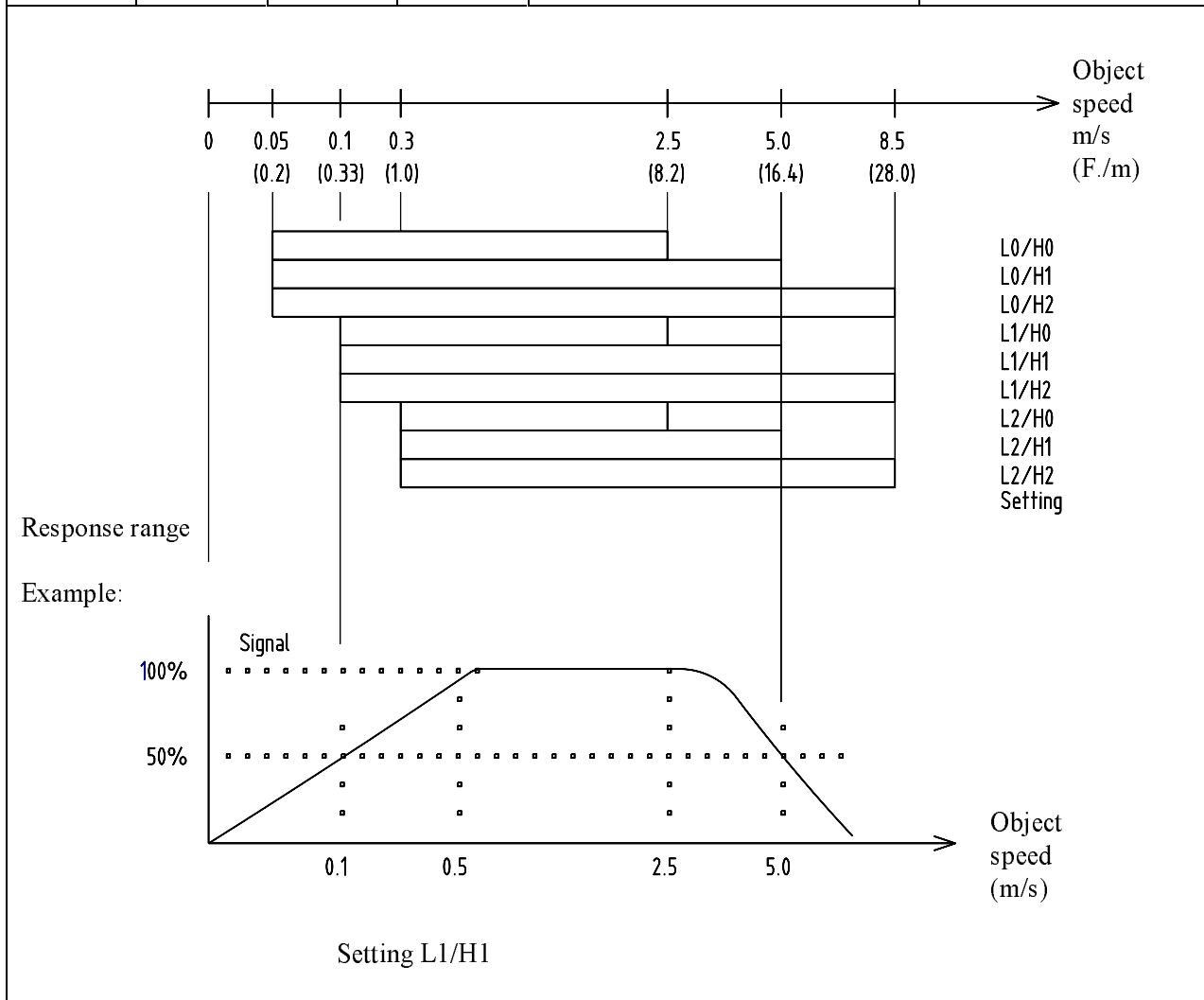

**4.7
Alarm
Inhibition
Operations**

The alarm inhibition operation, when controlled to active state, **prevents the operation of alarm outputs** of the Metor 150. During the active state, the audible signal and the visual alarm display in the control unit, and the alarm contact of the relay in the electronics unit do not operate.

The operation can be used to prevent the spurious alarms caused by external moving metal or strong electromagnetic interferences. The operation is useful only if the noise signals are occasional.

The function is controlled externally with the normally open contact connected to the electronics unit. Two connections can be made to have two different operations. This includes:

- the dynamic alarm inhibition operation; and
- the static alarm inhibition operation.

The dynamic alarm inhibition is triggered to active state by closing the contact in the control switch. The active alarm inhibition time is preset to the fixed 0.5 second.

The static alarm inhibition is activated by closing the contact in the control input. The active time is the closing time for the contact and the operation will be normal after a half second from opening the contact. The active state is indicated in the dot matrix display with the "AI" code.

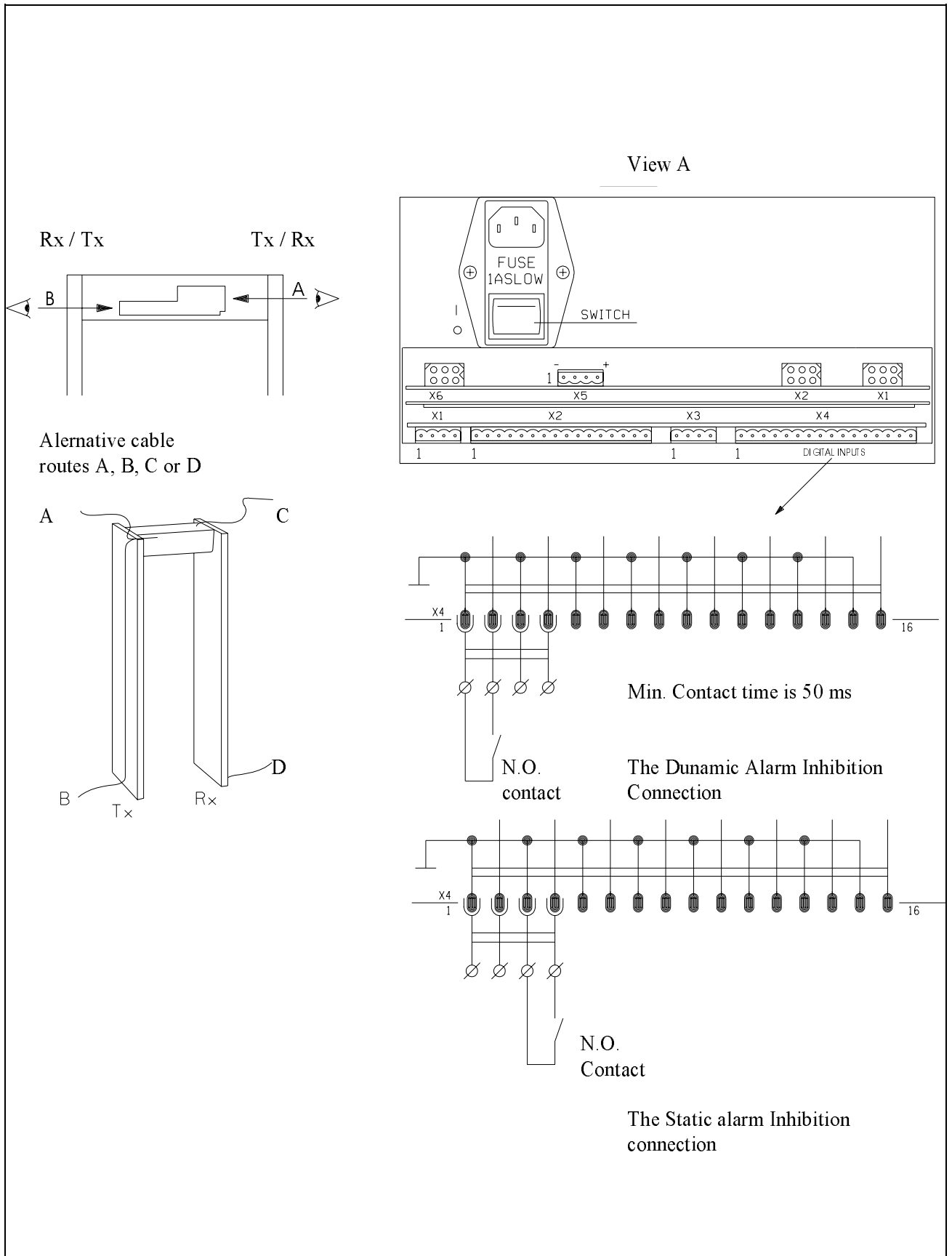

Figure 4-7. Connections for alarm inhibition operations

SECTION 5

SPECIAL CONSIDERATIONS

5.1 Theory of Operation

It is best to know something about how metal is actually detected, before changing the settings from their default values. By understanding how the changes you make affect the performance of the gate, you will be able to select the optimal program settings.

A magnetic field is produced inside the gate. This field induces eddy currents in metal that is passing through the magnetic field. These eddy currents produce a signal in the receiver coil of the gate. This signal is monitored by the detection circuitry and, if it is large enough to exceed the alarm threshold, will produce an alarm.

5.1.1 Shape vs. Weight

The shape and surface area of the metal object are just as important as the amount of metal in determining the signal seen by the detection circuitry. For example, take a sheet of aluminum foil, cut it in half, roll one into a ball and leave the other flat. The flat sheet has a larger surface area than the ball and will be much easier to detect. The ball weighs the same but due to its reduced surface area, will require a higher sensitivity setting to give the same detection performance. Typically, a rod-shaped object is the most difficult shape to detect.

5.1.2 Metal Types

Different types of metal also produce different signal levels. Ferrous metals, like steel and iron, are easiest to detect. Non-ferrous metals such as gold, silver, aluminum and stainless steel require a higher sensitivity setting to obtain the same results.

When gold is the desired target, a very high sensitivity setting is required. Also, a gold ring is much easier to detect than a gold chain of the same weight. This is due to the surface area of the ring producing a signal which is larger than the sum of the signals produced by the individual links of the gold chain. It takes approximately three (3) times the weight in gold chains to equal the detection capability for gold rings.

**5.1.3
Ambient Signal**

When the metal detector is operating, the display may exhibit one or more blinking green led's while no one is going through the gate. These fluctuations are normal and are due to the ever-present nominal level of ambient electrical interference that is produced by all the electrical devices in use today.

When a metallic object passes through the gate, a signal is detected. If the metallic object produces a signal large enough to exceed the alarm threshold, an alarm sounds. An ambient electrical interference problem can increase the alarm rate of all metal detectors, to a varying degree, by increasing the ambient signal level detected by the gate. Once this level is increased, it takes a lessor amount of metal to reach the alarm threshold, thus increasing the alarm rate. **For example**, if the alarm threshold was calibrated to pick up a person wearing trousers, running shoes, small brass belt buckle and a gold watch in their pocket, an increase in ambient signal interference may cause the gate to alarm when that same person goes through with just the metal belt buckle and no watch. This is only a problem when the interference level fluctuates drastically, causing from three to five green led's to blink in a random sequence.

The above scenario will be discussed further in the Interference Compensation, see chapter 6.4.

**5.1.4
Steel-
Reinforced
Shoes**

Metal is used in the manufacture of many types of ordinary shoes. Steel shanks are found in the soles for arch support; long nails are used in women's high heels; "safety" shoes have steel-reinforced toes. All of these common metal items can add to the alarm rate.

SECTION 6

MAINTENANCE

6.1 Cleaning

With the power source disconnected, clean the outside of the gate with a cloth moistened in a mild detergent.

6.2 Service Requirements

The Metor 150 does not need regular tuning or Servicing maintenance unless the settings or the environment changes, or a fault occurs.

If the Metor 150 shows signs of **external damage**, such as dents that may have occurred during shipment, the equipment should be checked by a qualified technician.

Servicing is required when the internal fault diagnostics code is displayed or the Metor 150 is not operating properly.

6.3 Fault Tracing and Display

The Metor 150 has an **internal fault diagnostics procedure** which controls the functions during operation and checks the electronics when the system is switched on.

The condition is indicated by an audible intermittent signal (| - - - |) and an error code (ER/error no.) is displayed by light dot matrix in the control unit. The meanings of and the corrective actions for the error codes are shown in figure 6-2.

If the indicated fault is a **temporary break down**, the system continues operation automatically after one minute. In case of a **permanent fault**, the state is indicated constantly and must be corrected to resume normal operation. An error code indicating a permanent fault can not be shunted.

The temporary break down may be caused by **an operator when adjusting** the detector. The reason may also be **changes or interferences in environment**.

The corrective actions consist of rechecking the installation and settings or replacing the faulty part. Figures 6-1, Fault Tracing Guide, 6-7, Tracing for Interference Source, and 6-8, Interference Compensation, outline the principal steps to make corrections.

In most cases, **the settings can be checked and adjusted during the fault indication** (see chapter 3.2). When you have the error message on the display (not "***" figure), enter the access key code. Wait a moment to have a stand by or an alarm display and (regardless of the display message after appr. 0.5 min) make your settings in normal way by starting with PRG key.

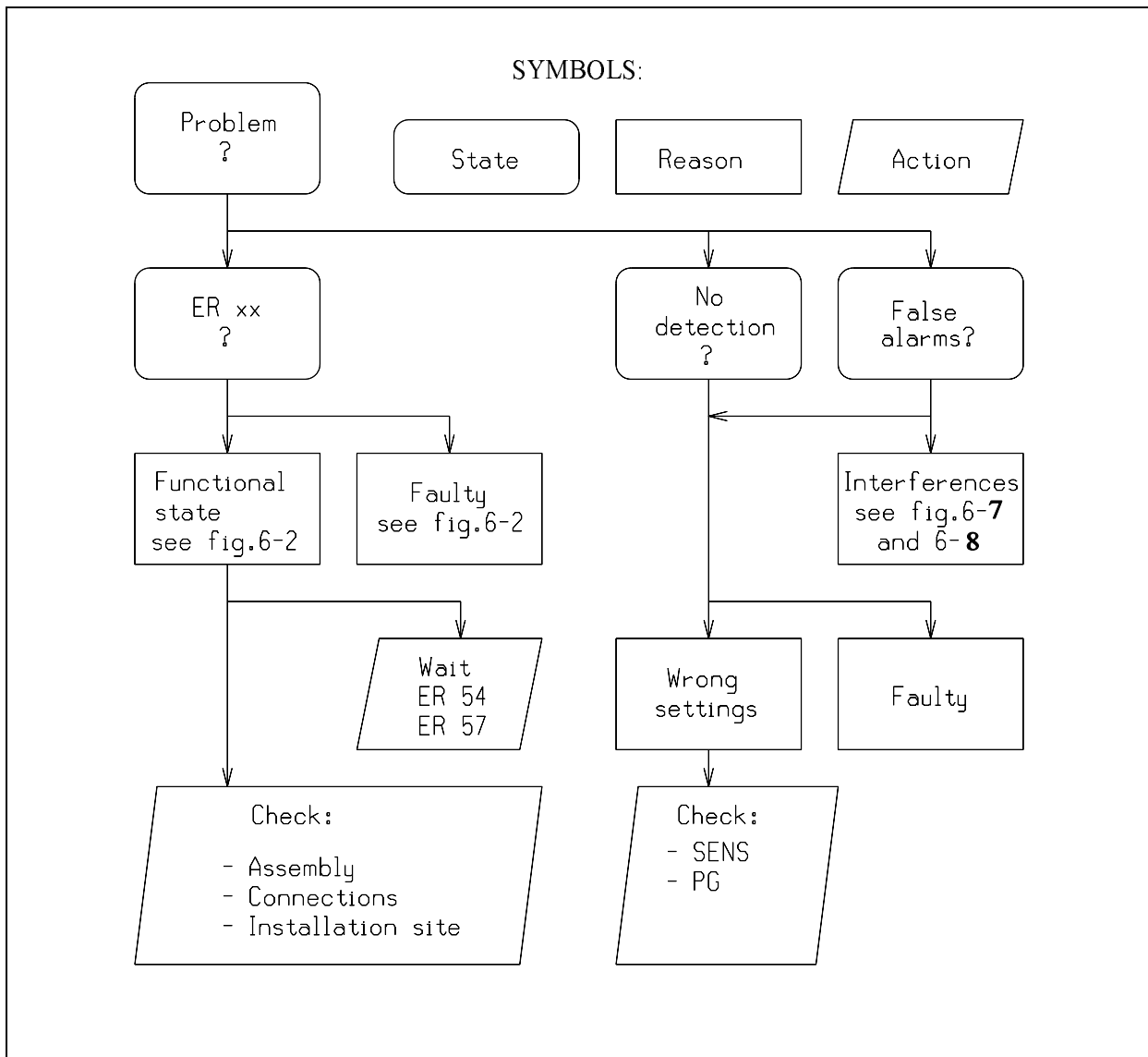

Figure 6-1. Fault Tracing Guide

Figure 6-2. **Error numbers, symptoms, causes and corrective actions**

ERROR NO	SYMPTOMS	POSSIBLE CAUSE	CORRECTIVE ACTION
-	The unit does not work. No reaction to metal, no display.	Power cable poorly connected or faulty. Mains fuse blown. Control unit cable poorly connected or faulty. Battery operation: -Battery cable poorly connected or faulty -Battery discharged.	Check connections or replace cable. Replace fuse (T1A). Check connection or replace cable. Check connection or replace cable. Charge battery.
-	Alarm relay faulty although audible and visual alarm is normal.	Relay fuse faulty in MMCU board.	Replace fuse (T2A).
00-09	Control unit error.	Electrical break.	Replace Control unit.
03	Invalid MCPS sw.version.	MCPS software version not accepted by MELS.	Check that MCPS sw. ver.is compatible with MELS software.
10-19	Electronics unit error.	Electrical break.	Replace Electronics unit.
20	Receiver cable open.	Cable poorly connected.	Check connection.
21	Transmitter cable open.	Cable poorly connected.	Check connection.
22	Gate error	Coil cable(s)poorly connected or faulty. Coil panel(s)faulty. Electrical fault. Coil gap too wide or large static metal plates too close to coil.	Check connections or replace cable(s). Replace coil panel(s). Replace electronics unit. Decrease coil gap to distance without error message, if standard gap not used. Increase the distance of static metal to coil. If special construction is needed (wide coil gap or metal plates) inhibit the operation of error no. 22 by using program 56 (see chapter 3.4.2).

Figure 6-2. (continued)

ERROR NO	SYMPTOMS	POSSIBLE CAUSE	CORRECTIVE ACTION
30-39	Undefined error	Electrical fault.	Replace electronics unit.
40-49	Functional break down.	External interferences.	<p>Check the stability of mains and environmental magnetic fields e.g. by testing operation in other place.</p> <ul style="list-style-type: none"> - Change the place of the M150 or - Try to decrease the interference level, e.g. by filtering noise source or locate source and increase the distance between it and the M150. <p>Test the operation of M150 with other operation frequencies MODE/F or with signal filters H0 and L2 (see mode settings, chapters 3.2 and 4.6).</p> <p>Check all settings, if they have changed make the appropriate corrections (see chapter 3.2).</p> <p>Test operation with another program see chapters 3.2 and 3.3).</p>
		Electrical fault.	Replace electronics unit.
40	User error.	Keying error with MODE key.	See mode settings chapter 3.2.
44	Parameter error.	Electrical interference.	Check all settings also mode (see chapter 3.2).
48	Communication error.	Keying error.	See chapter 3.2.
		Control unit cable poorly connected or faulty.	Check connection or replace cable.
		Electronics unit faulty.	Replace electronics unit.
		Control unit faulty.	Replace control unit.

Figure 6-2. (continued)

ERROR NO	SYMPTOMS	POSSIBLE CAUSE	CORRECTIVE ACTION
50-59	Temporary breack down.	External interference. Electrical fault.	Change the place and/or position of the M150. Replace electronics unit.
52, 53	Channel saturated.	Too large a metal object. Static metal too close the M150. Coil panels too close each other.	When metal is moved away, operation is normalized. Increase the clear space between the M150 and the static metal. Note when installing without cross piece.
54	DSP range alarm.	(See ER 52, 53)	(See ER 52, 53)
57	Offset compensation.	The amount of static metal changes or the proximity of coil to static metal has changed.	After a moment operation is normalized.

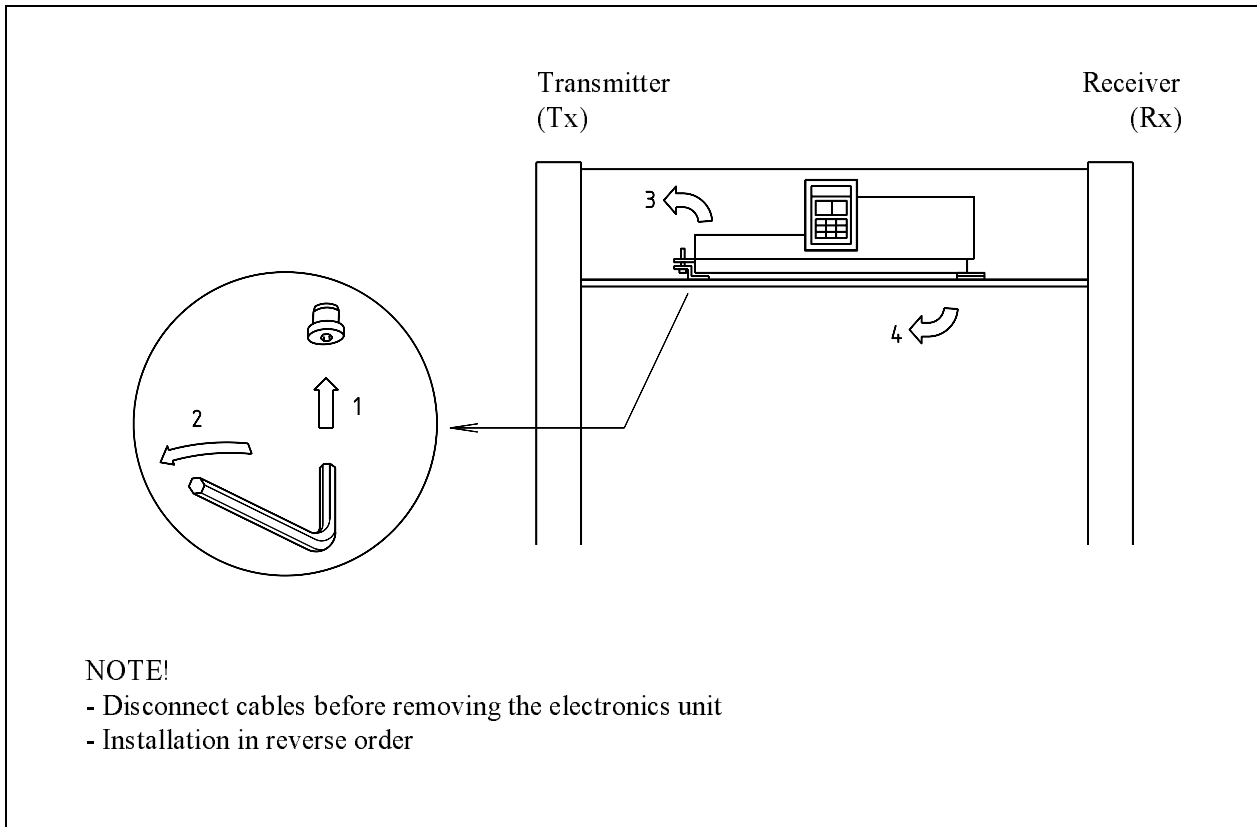

Figure 6-3. Removing the electronics unit

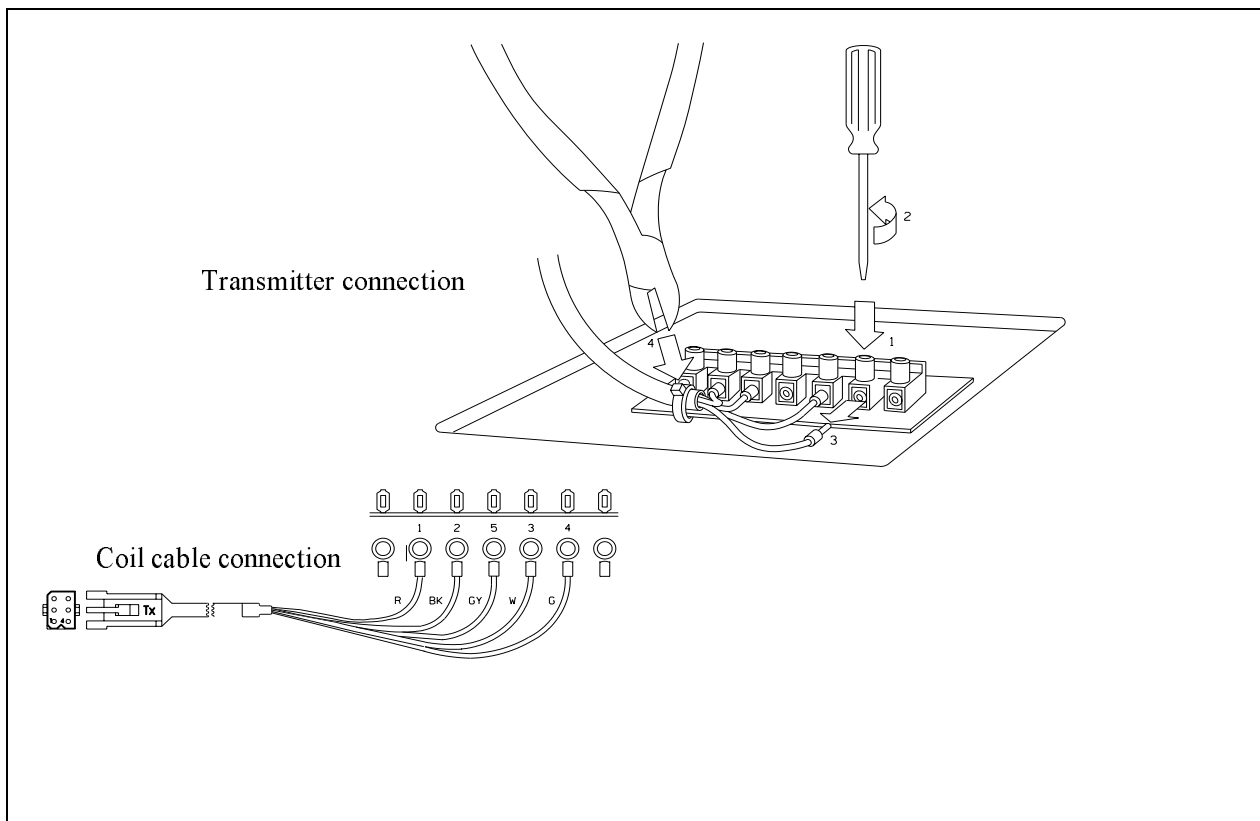

Figure 6-4. Removing the transmitter coil panel cable

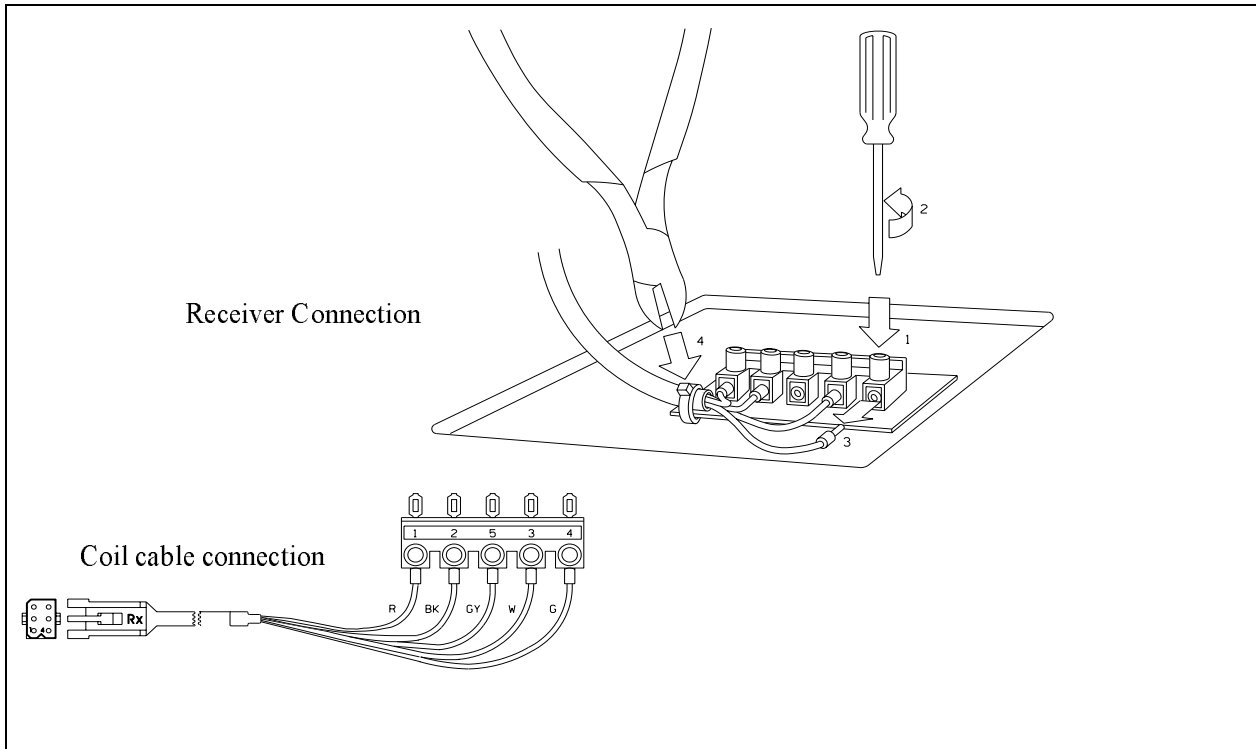

Figure 6-5. Removing the receiver coil panel cable

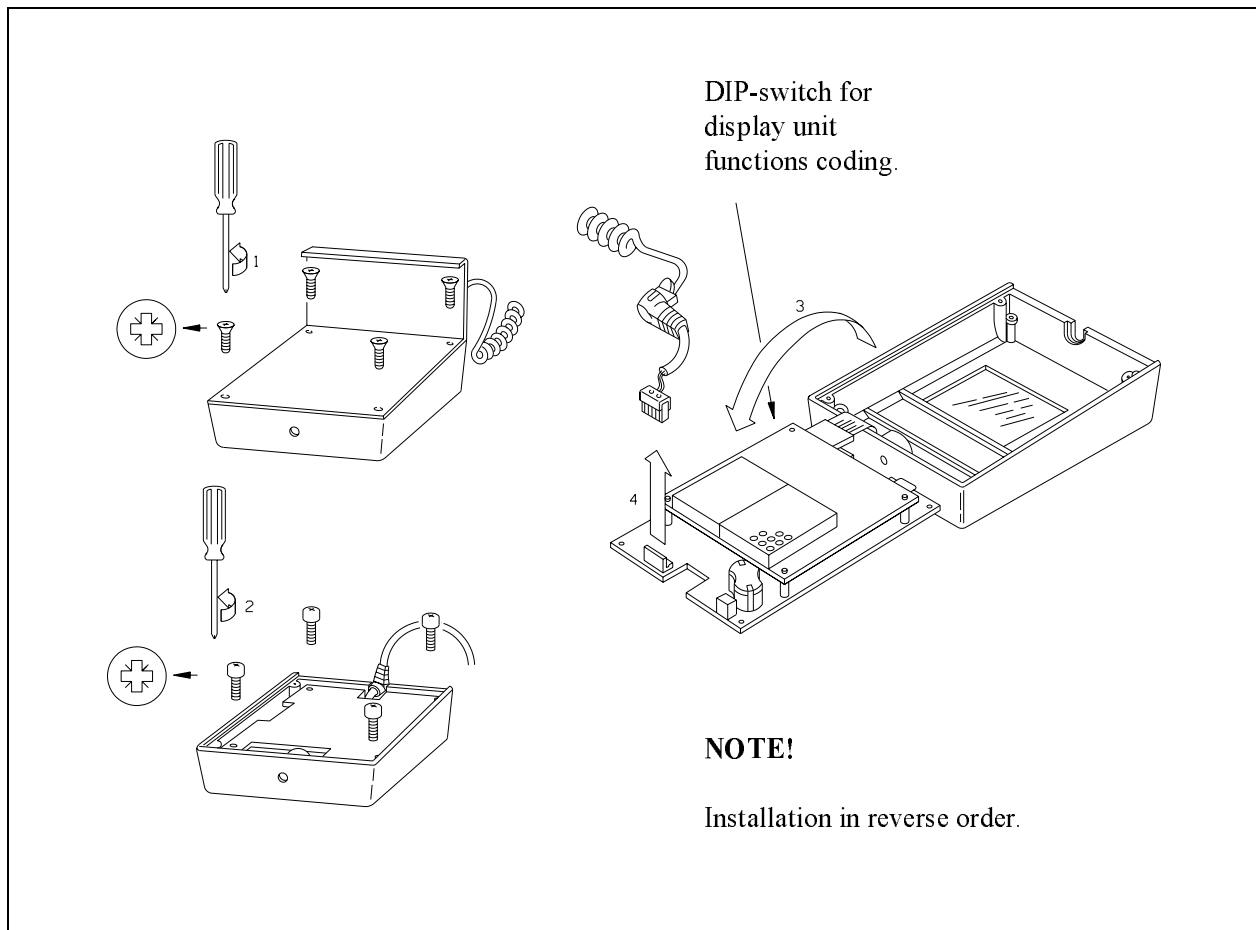

Figure 6-6. Removing the control unit cable

6.4 Interference Compensation

The Metor 150 is typically used at maximum sensitivity to detect small amounts of metal. At this sensitivity range, the possibility of a varying detection capability due to electrical interference is a problem that we will discuss, and guide the programmer through the necessary steps to reduce or eliminate this phenomenon. It is most important that the guidelines in the installation have been met before proceeding (see section 2).

Varying detection capability is typically caused by a varying ambient signal level, due to electrical interference (see ambient signal, chapter 5.1.3). This RFI (Radio Frequency Interference) can be controlled by:

1. ensuring all the recommendations in the installation have been observed (see section 2); and
2. the following programming procedure is followed.

The visual display of the Control Unit (MCPS) indicates the ready mode by a large block of green lights (Light Emitting Diode's or LED's) and the alarm mode by a large block of red lights (LED's). Also, below these blocks is a horizontal bar of five green and five red LED's which indicate the relative amount of metal passing through the gate. This light bar also may have blinking green LED's, with no one going through. These light fluctuations are caused by ambient signals.

The Metor 150 allows the user to select one of the internal operating frequencies (per program), to shield it's circuit operations from the interference frequency of the ambient signal. Selecting the correct frequency will effectively reduce the blinking display light fluctuations to a stable level. This is done by going into the program mode (see frequency adjustment, MODE F) and selecting one of those frequencies per program. Please remember that all changes to one program do not effect any other program.

Sequence through all of the frequencies, one at a time, to see which one gives the least amount of flickering green LED's and appears most stable. Select one frequency, F0, hit enter twice and observe the display. Select the next frequency, F1, hit enter twice and compare this to the previous display. Do this for all frequency settings and record results. The following figures detail the principal ways to find out the interference source and the steps which can be carried out to improve the operation.

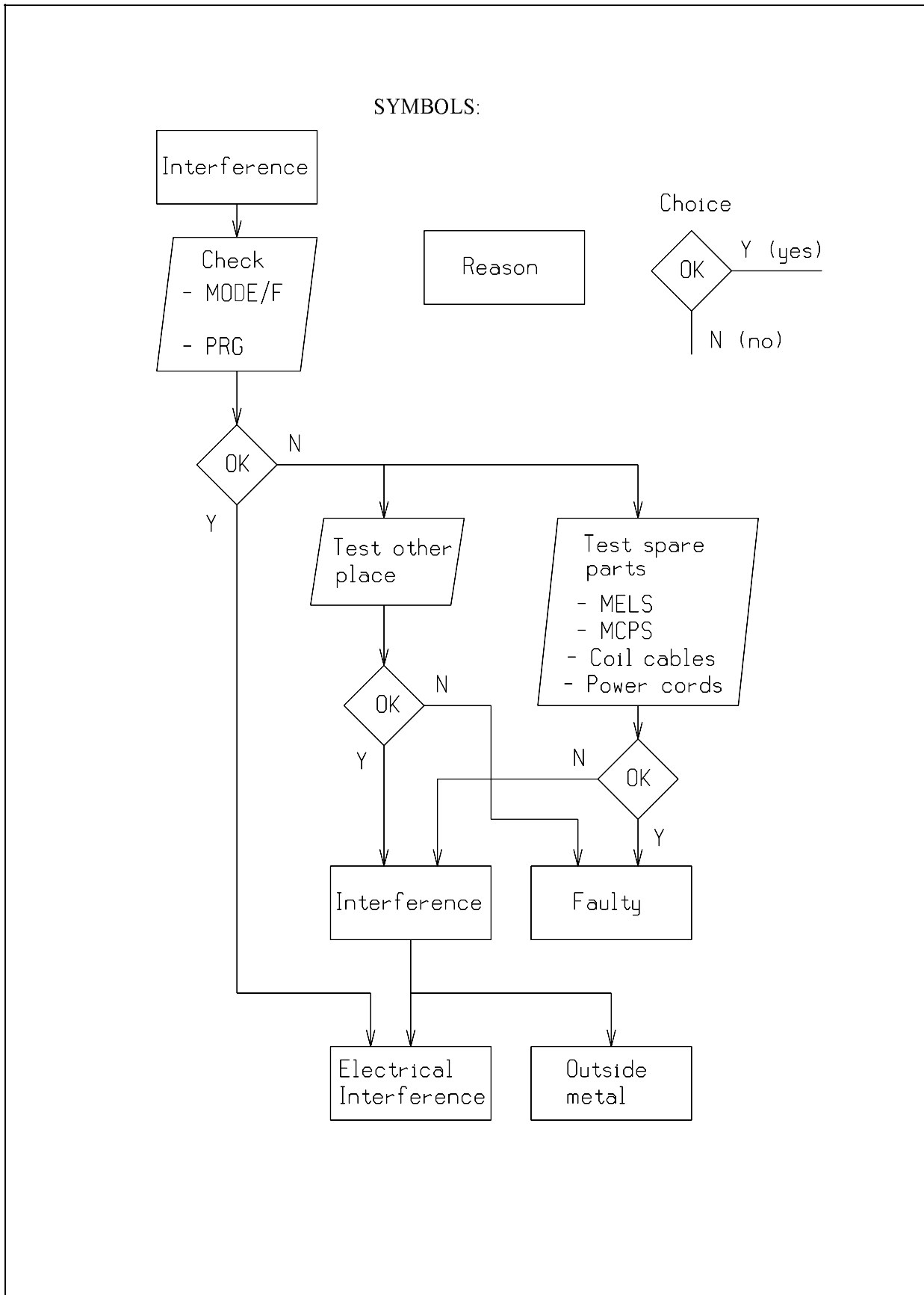

Figure 6-7. Tracing for interference source

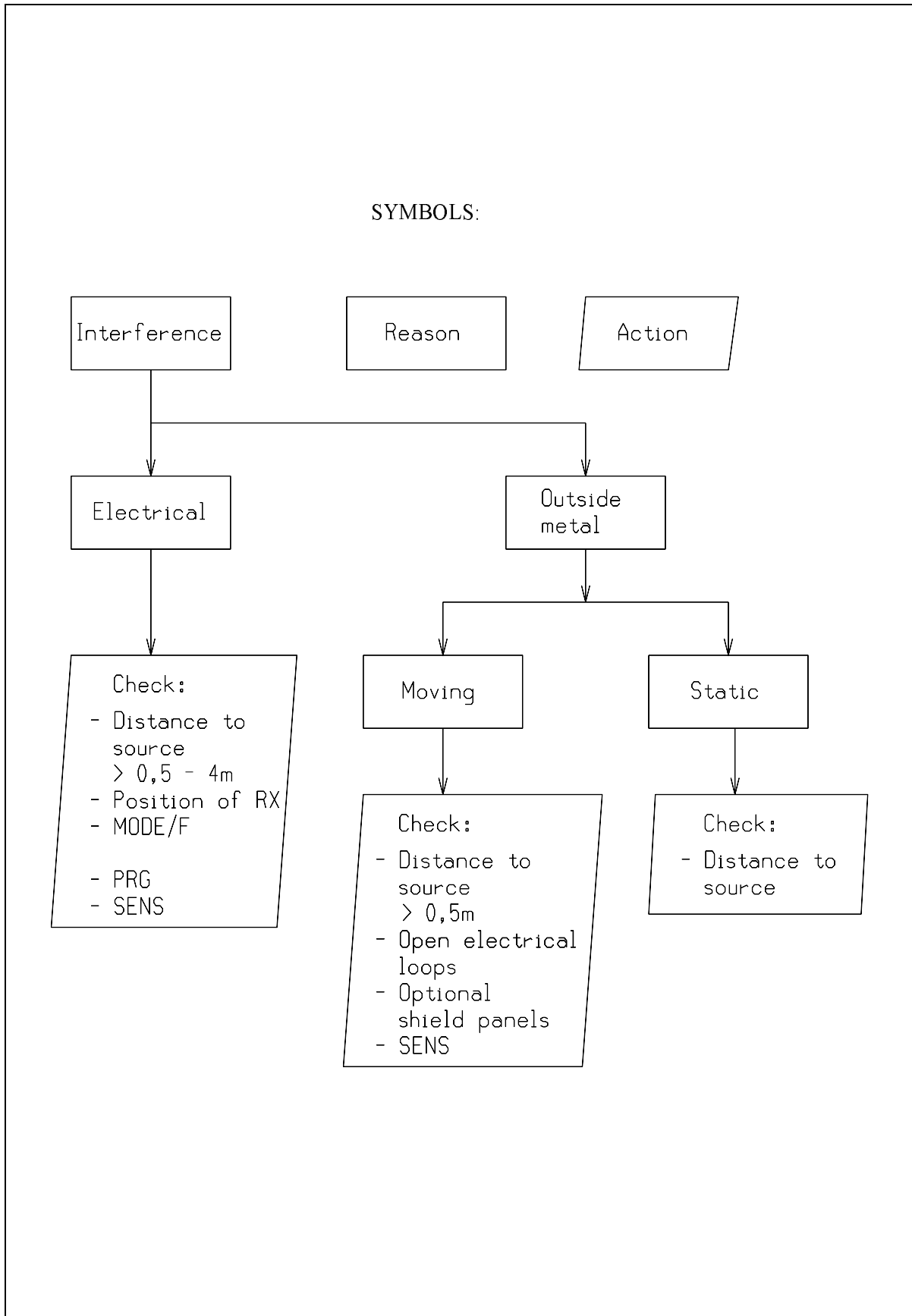

Figure 6-8. Interference compensation

6.5 Spare Parts

When spare parts are ordered, please specify

- **Quantity.**
- **Part number.**
- **Name/type of the part.**
- **Software version** if the part is
MCPS, MELS or electronics board MMCU.

All mechanical and electrical components of the Metor 150 are available from Security Products Oy.

The following spare parts and testing accessories can be supplied:

- 1) MELS 1761.1 (part no. 8100 254), an electronics unit.
- 2) MCPS 2235.7 (8100 255), a control unit with cable.
- 3) MCLS 5040 (8100 104), a gate including coil panels and cross piece.
- 4) MTXS 5042 (8100 106), a transmitter coil panel with cable.
- 5) MRXS 5043 (8100 107), a receiver coil panel with cable.
- 6) MCSS 5 141 (8100 105), a cross piece.
- 7) Transmitter coil cable (8100 203).
- 8) Receiver coil cable (8100 204).
- 9) MCPS cable (4100 396).
- 10) Power cord 230V 2,5m (2459 857).
- 11) Power cord 230V 5m (3058 290).
- 12) Power cord 115V 2m (3056 520).
- 13) Power cord 115 V 5 m (3058 291).

14) On-site kit (8100 199), a spare part kit which supports the on-site fault tracing instructions in this manual. Content:

- coil cables with wire ties
- control unit cable
- 2 pcs, power cord (with 115 and 230 V plug)
- 1 pcs, 4 wire screw terminal/plug-in connector
- 1 pcs, 7 wire screw terminal/plug-in connector
- 10 pcs, mains fuses T1A
- 10 pcs, relay fuse T2A
- 10 pcs, digital output fuse T0.5A
- 10 pcs, 5 V digital output voltage fuse T0.2A
- 10 pcs, battery voltage fuse T3.15A
- 8 pcs, coil panels mounting bolts and allen key 4 mm.

15) Simulation coil (3880 955), a small test coil that can be used instead of the normal coil for testing and servicing purposes.

16) Extension coil cables (3881 050). They are needed when the electronics unit is outside the cross piece for test and maintenance.

6.6

Optional Accessories

Optional Gate Wheel Kit (part no. 8100 198)

- 2 Motor Caster Assemblies
- 4#8 x 1 S/S Phillip Flat wood screws
- 2 handles
- Assembly instructions

SECTION 7

TECHNICAL SPECIFICATIONS

7.1

Meteor 150

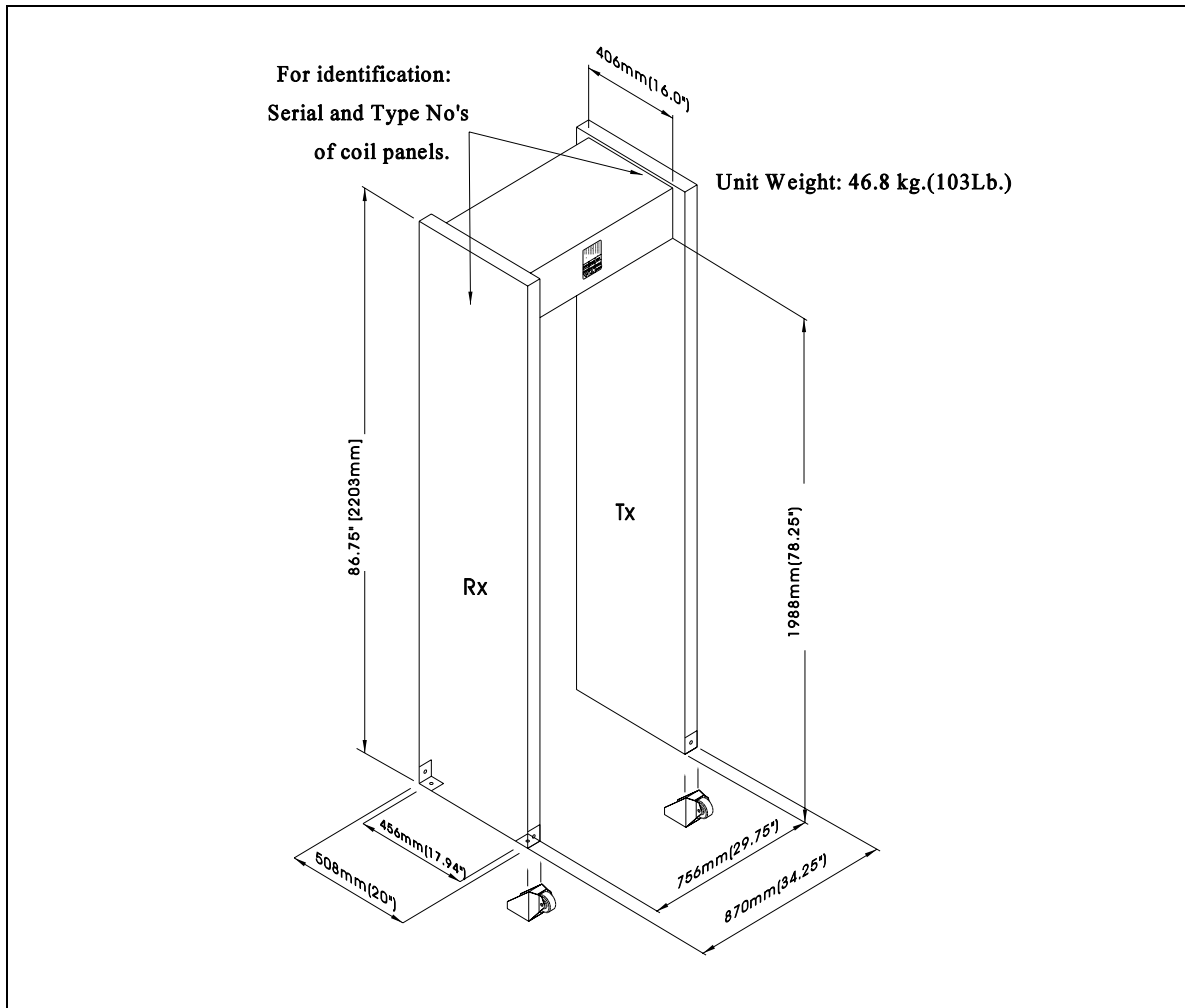

Figure 7-1. Dimensions and weight of the Meteor 150

Ambient operating temperature:

- -10°C - +55°C (14°F - 131°F)

Relative humidity of operating environment:

- Up to 95%, no condensation.

Degree of protection:

- **Ordinary IP 20 as per IEC 529 for dry indoor environments.**

Power supply:

- **Mains voltage 95 - 250 VAC, 50 or 60 Hz, 50 VA.**
- **Battery voltage 20 - 30 VDC, 35 W.**

Regulatory compliance:

- **IEC 348, E 380-84 (IEC 380-77), E 380A85.**

This apparatus has been designed and tested in accordance with publications mentioned above, Safety Requirements for Electronic Measuring Apparatus, and has been supplied in a safe condition. The present instruction manual contains some information and warnings which must be followed by the user to ensure safe operation and to keep the apparatus in safe condition.

- **NILECJ-STD-0601.00**

This standard, issued by the U.S. Department of Justice, covers walk-through metal detectors used to detect weapons. It contains specifications for design, performance and maximum permissible strength of the magnetic field.

The Metor 150 meets the magnetic field and 1-5 security level requirements of this standard.

- **Surge voltage transient test to mains supply according to IEEE Std. 472.**

The characteristics of the disturbance signal were: burst frq 1 MHz, max. amplitude 2.5 kV, repetition frq 400 Hz, coupling to mains input symmetric/asymmetric, source impedance 200 ohms and test signal duration 10 sec.

- **Effect of Metor 150 metal detector to cardiac pacemakers.**

The research, by Tampere University of Technology, includes laboratory and clinical tests. As a conclusion of the study, it was verified that the Metor 150 is safe for persons with pacemakers walking through the gate.

Similar results have been concluded in the research report by Electric Heart Stimulation Centres - "La Sapienza" University and Cardiology Dpt, "Villa Valeria" Clinic, Rome, Italy.

7.2

Electronics Unit

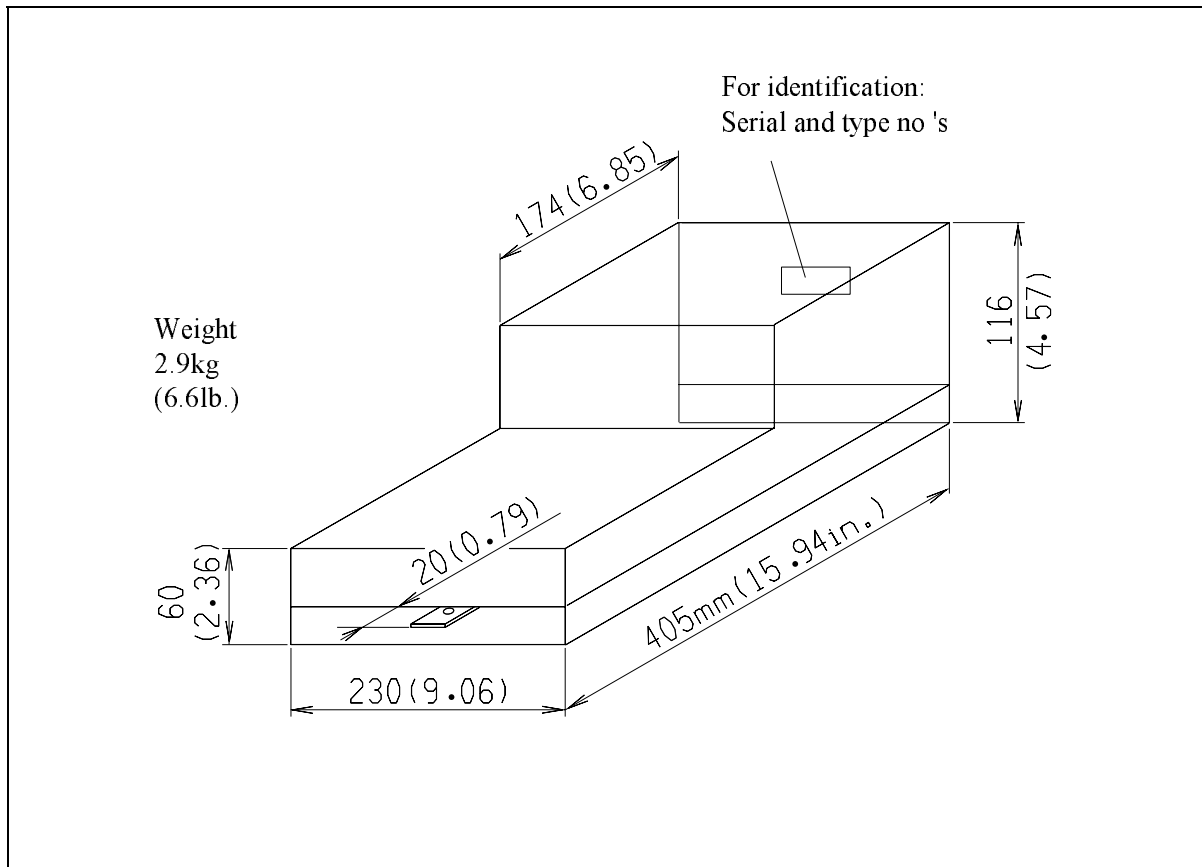

Figure 7-2. **Dimensions and weight of the electronics unit type MELS 1761.1**

Electrical connections:

- **Mains voltage 95 - 250 VAC, 50 or 60 Hz, 50 VA.**

Connector set for plug connector IEC 320/VI (DIN 49457) with single-pole fuse holder, mains switch and line filter.

Protected with T1A fuse dia. 5x20 mm.

Cable length 4m (157 in.) (from top of the gate).

- **Battery voltage 20- 30 VDC, 35 W.**
 Screw terminal/plug-in type connector.

- **Transmitter panel.**

Plug-in type connector.

Cable length 0.5 m (20 in.), recommended
 max. 5 m (197 in.).

- **Receiver panel (See transmitter).**

- **Control unit.**

RS-232-C communication bus (not isolated).

Plug-in type connector.

Cable length flexible 0.5 - 2.0 m (20-79 in),
recommended max. 60 m (195 ft.).

- **Display unit (See control unit).**

- **Alarm relay.**

Single pole double throw (SPDT) voltage free contact.

Contact ratings 2A at 24 VDC or 120 VAC, resistive.

Dielectric strength 750 VAC (50/60 Hz).

Fuse protection T2A dia 5x20 mm.

Screw terminal/plug-in type connector.

- **Digital input and output.**

Programmable functions (depends on software). Outputs protected with T0,5A dia. 5x20 mm fuse. Screw terminal/plug-in type connectors.

- ▶ Dynamic alarm inhibition input with 0,5 sec operation, connector terminal X2/2, min. ON/OFF time 50 msec. for control contact.
- ▶ Keyboard inhibition input, connector terminal X2/16.
- ▶ Static alarm inhibition input, connector terminal X2/4.

- **5 V output, supply for digital output.**

Fuse protection T0.2A dia. 5x20 mm.

Screw terminal/plug-in type connector.

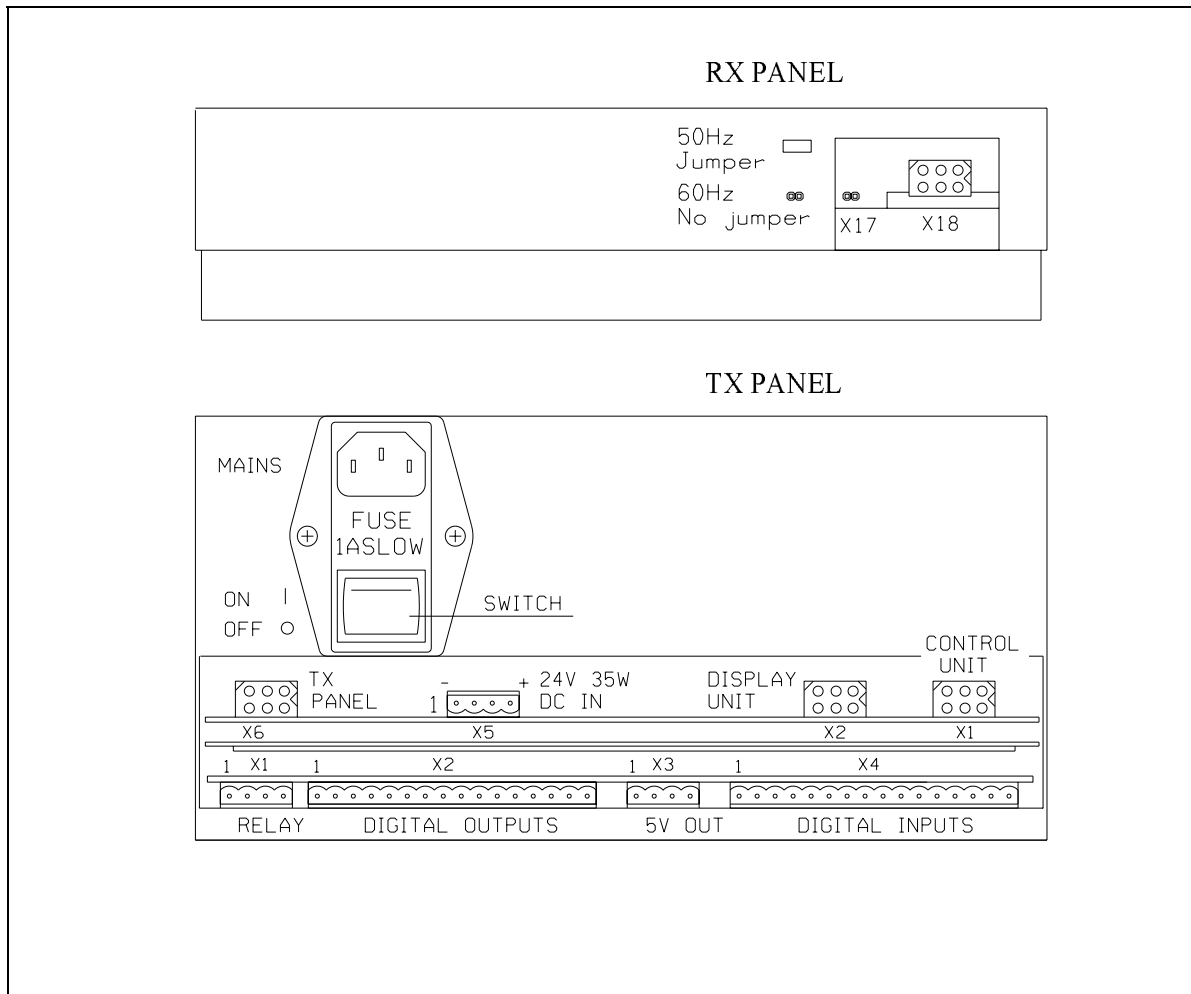

Figure 7-3. Connections of MELS 1761.1

Controls:

- **Mains voltage on/off switch.**
- **50/60 Hz mains frequency selection.**

7.3

Control Unit

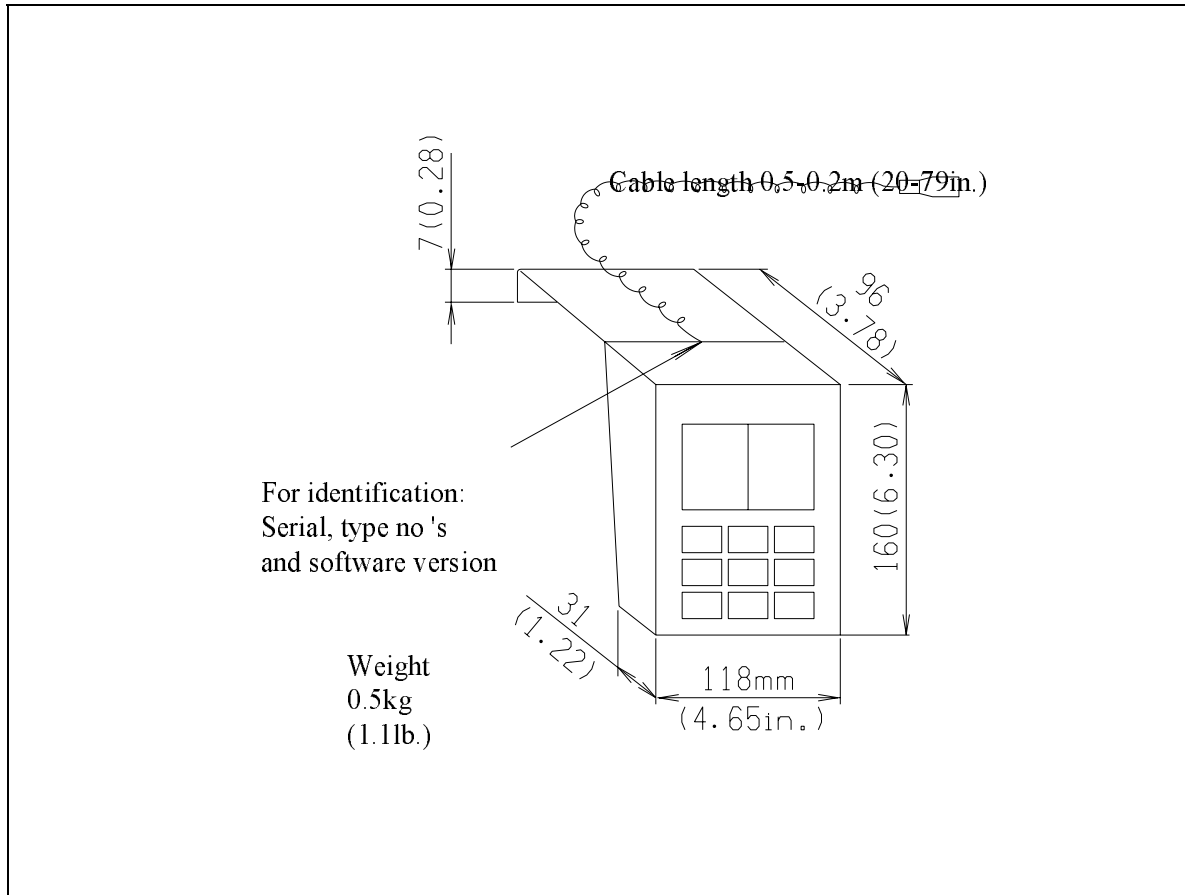

Figure 7-4. Dimensions and weight of the control unit type MCPS 2235.7

Main functions:

- **Control unit**

LED matrix display for visual indication, audible alarm signal and keyboard for controls.

- **Display unit**

- ▶ Operation selectable from DIP switches inside the Control unit. Since software ver. MCPS 1.20.
- ▶ LED matrix display and audible signal.

Connections:

- **Control unit to electronics.**

Compact spiral cable with plug-in type connector.
Cable length flexible 0.5 - 2.0 m
(20 - 79 in.), recommended max. 65 m (215 ft.).

Controls:

All the controls are on a membrane type keyboard. Three key access code to enable the operation (except audible volume and manual reset). Display-/control unit operation selection from DIP-switches inside MCPS.

- **Operators settings**
 - ▶ Audible alarm volume adjustment with 01 - 09 scale.
 - ▶ Manual reset (if in operation).
- **Access code settings**
 - ▶ Sensitivity adjustment with 00 - 99 scale.
 - ▶ Minimum volume setting
 - ▶ Audible alarm tone selection with three tones.
 - ▶ Automatic/manual reset selection.
 - ▶ Program selection. (MELS software version specifies the programs.)
- **Mode selection for object speed response.**
- **Mode selection for operation frequencies.**

Indications:

- **Audible alarm signal.**

Metal detection, operation of key and fault indication.
- **Two 5x7 LED-matrices for displaying the static standby and alarm lights, dynamic signal amplitude, error codes and the state of electronics when settings are made.**

APPENDIX 1

ALPHABETICAL INDEX

Subjects referred to the chapter and figure numbers.

A

Access Code adjustment mode	3.2
Adjustments	3.2
Auto/Manual reset	3.2/Fig.3-9
Filter	3.2/Fig.3-10
Mains frequency	2.3/Fig.2-5
Min. volume	3.2/Fig.3-7
Mode	3.2/Fig.3-10,4.1
Operation frequencies	3.2/Fig.3-10,4.1, 6.4
Power switch	3.1
Program	3.2/Fig.3-5
Sensitivity	3.2/Fig.3-4
Tone	3.2/Fig.3-8
Volume	3.2/Fig.3-6
Alarm Contact	4.2
Alarm Inhibition	4.6
Applications	
Program Selections	3.3
General Information	1.1
Assembly	2.3
Automatic reset	3.2/Fig.3-9

B

Battery Back-up	4.4
------------------------	-----

C

Cleaning	6.1
Coil panels	
Assembly	2.3
Cables, removing	6.3/Fig.6-4, 6-5
Introduction	1.1
Connections	
Basic connections	2.4
Control Unit	7.3
Electronics Unit	7.2

C continued

Construction	1.1
---------------------	-----

Control unit

Cable removing	6.3/Fig.6-6
Display Unit	4.5
Operations / location	3.2/Fig.3-2
Specifications	7.3

Cross Piece

Assembly	2.3/Fig.2-8
Introduction	1.1

D

DC supply	4.4
Detection Parameters	
Software version WD01	3.3.1
Detection Programs	3.3
Display	
Switching on	3.1/Fig.3-1
Functions	3.2/Fig.3-2
Display unit	4.5
Dual-channel operation	1.2

E

Electronics unit

Assembly	2.3
Introduction	1.1
Removing	6.3/Fig.6-3
Specifications	7.2

Error codes

6.3

Extension coil cables

6.5

External interferences

Compensation	6.4
Installation site	2.1

Factory settings

3.4.1

Fault tracing and displays

6.3

Floor Mounting Brackets

2.3/Fig.2-8

Filter

Adjustment	3.2/Fig.3-10
------------	--------------

Frequency	
Mains frequency	2.3
Operation frequency	3.2/Fig.3-10, 4.1

I

Installation	
Location	2.1
Power cord	2.3/Fig.2-6
Assembly	2.3
Connections	2.4
Inhibition	
Alarm	4.6
Keyboard	4.3
Interference (see External interferences)	
Introduction	1.1

K

Keyboard	
Display unit	4.5
Functions	3.2/Fig.3-2
Inhibition	4.3

M

Mains frequency setting	2.3
Mains voltage	3.1
Manual reset	3.2/Fig.3-9
Minimum volume	3.2/Fig.3-7
Mode	3.2/Fig.3-10
Multiple array operations	4.1

N

Noise attenuation	
Adjustments	3.2/Fig.3-10
Compensation	6.4
Programs	3.3.2

O

On-site kit	6.5
Operation	3.3
Operation frequency	
Adjustment	3.2/Fig.3-10
Multiple array operation	4.1

Operating principle	1.2
Operator adjustment mode	3.2
Optional Accessories	6.6

P

Packing	2.2
Power cord	
Installation	2.3/Fig.2-6
Introduction	2.4/Fig.2-7
Power switch	3.1
Programs	
Adjustments	3.2/Fig.3-5
Detection	3.3
Pulse-field technology	1.2

R

Relay	4.2
Reset	3.2/Fig.3-9

S

Security check point layout	2.1.2
Sensitivity	3.4.5,3.2/Fig. 3-4
Service reporting	Appendix 2
Servicing requirements	6.2
Simulation coil	6.5
Software versions	3.3.1
Spare parts	6.5
Specifications	
Control unit	7.3
Electronics unit	7.2
Metor 150	7.1
Switching on/off	3.1
Synchronization	4.1

T

Technical specifications (see specifications)	
Tone	3.2/Fig.3-8

U

User selectable programs

Program selection	3.3
Test and setting	3.4.

V

Voltage supply

Battery	4.4
Frequency	2.3, 2.4/Fig.2-11
Mains	2.3/Fig.2-6, 2.4
Power consumption	7.1

Volume	3.2/Fig.3-6
---------------	-------------

APPENDIX 2

SERVICE REPORT PROCEDURE

Why service reporting?

Rapiscan Systems Oy aims to offer high quality, reliable products to the user. To accomplish this goal, reliable information concerning service activities and problems is needed from the field. It is this communication, in the form of service reporting, that makes it possible to specify cases clearly and file them for further use.

Information contained in completed service reports is the basis to our quality control of problematic areas and allows us to begin corrective action.

The service reporting procedure also communicates to the user the specific actions taken to solve the problem.

In these efforts to improve product quality, we ask for your cooperation in using the reporting procedure.

Service report procedure

The reporting is done by using the multicopy form. The first copy is the customer copy (white). The second is for technical service and marketing (blue). The third is for quality control (red). The fourth is the service engineer's copy (yellow).

The following principles are used in the reporting:

- Warranty requests can not be handled if the service report is missing.
- If faulty units are sent to us for repair, the first three copies of the service report must be enclosed and contain information about fault symptoms. The customer copy, with repair data, is returned with the repaired unit.
- If the fault is repaired in the field by the user or a Metor representative, the second and third copies should be sent to the factory.
- All faults which generate service activities should be reported. This includes faults caused by hardware fault, user mistakes, and application problems.
- The service report forms are available from the factory. See contact information on the first page.